



# *Drive Isolation and AC Line Reactors*



*Specifically designed to accommodate the special voltage and kVA sizes unique to AC and DC drive applications. Shielded for extra protection from supply line transients.*



*AC Line Reactors are designed to protect DC motor drives, AC variable frequency drives and the motors they power.*



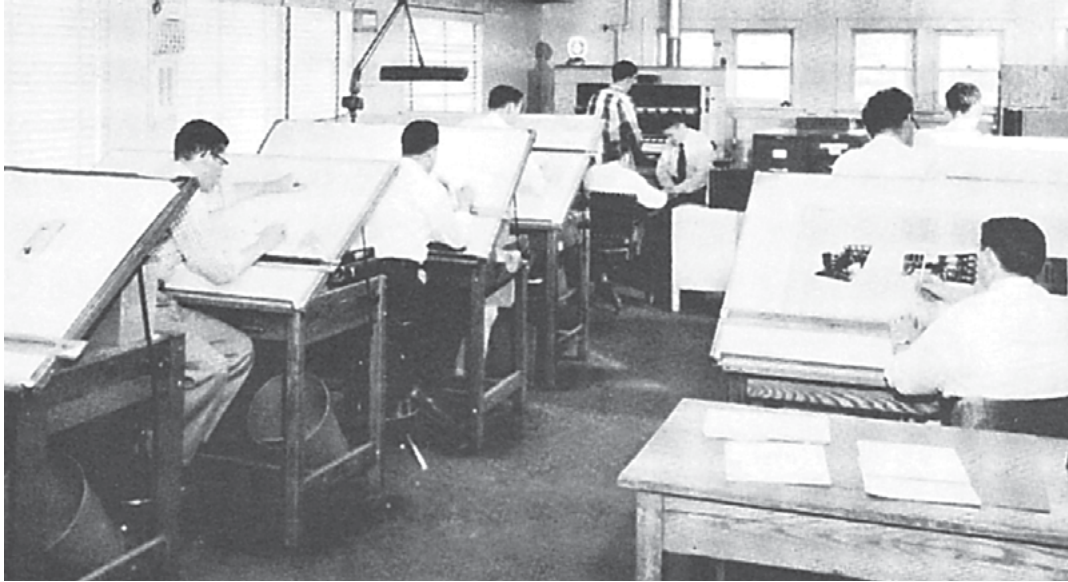

Acme Electric Drive Isolation Transformers are specifically designed to accommodate the special voltages and kVA sizes unique to AC and DC motor drive applications. Features include strip conductors to provide stress relief, wound cores and strip winding for lower eddy current losses, reduced short circuit forces and copper terminations for trouble-free operation.

Sections	Table Of Contents
<ul style="list-style-type: none"> <li>• Section 1: Dry-Type Distribution Transformers</li> <li>• Section 2: Medium Voltage Transformers</li> <li>• Section 3: Harmonic Mitigating &amp; Non-Linear Transformers</li> <li>• Section 4: <b>Drive Isolation &amp; AC Line Reactors</b></li> <li>• Section 5: Industrial Control Transformers</li> <li>• Section 6: DIN-Rail Power Supplies/Receptacles &amp; Low Voltage Lighting Transformers</li> <li>• Section 7: Buck-Boost Transformers</li> <li>• Section 8: Panel-Tran Zone Power Centers</li> <li>• Section 9: Power Conditioning Products</li> <li>• Section 10: Amveco Toroidal Solutions</li> <li>• Section 11: Custom Solutions</li> </ul>	<p style="text-align: center;"><b>Section 4: Drive Isolation &amp; AC Line Reactors</b></p> <p>General Description &amp; Features   Drive Isolation Transformers ..... 3 - 4</p> <p>Selection Charts ..... 5 - 6</p> <p>General Description &amp; Features   AC Line Reactors ..... 7 - 8</p> <p>Selection Charts ..... 9 - 10</p> <p>Encapsulated Line Reactors ..... 11</p> <p>Selection Charts ..... 12</p> <p>Wiring Diagrams ..... 13</p> <p>Accessories ..... 14</p> <p>Warranty &amp; Number Index ..... 15</p>

### DRIVE ISOLATION TRANSFORMERS

The Acme Drive Isolation Transformers are specifically designed to accommodate the special voltages and kVA sizes unique to AC and DC motor drive applications.

#### Features

- UL Type 3R Enclosures with Weather Shield on Ventilated Units (above 20 kVA). Type 2 Enclosure without weather shield. 7.5–20.0 kVA are encapsulated, UL 3R.
- 3-Phase 60 Hertz.
- 180°C and 220°C insulation systems.
- Encapsulated and ventilated designs. All ventilated units, are of strip wound construction. Acme's reinforced core assemblies enhance quiet operation.
- Nominally 6% impedance.
- Designed for use with AC, adjustable frequency or DC drives.
- Full capacity taps are featured on all units. On 7.5 through 20 kVA units, taps are 1-5% ANFC and 1-5% BNFC. On 27 through 880 kVA units, taps are 2-2 1/2% ANFC and 2-2 1/2% BNFC.
- Full range of kVA ratings cover all standard drive systems.
- Ample wiring compartment for easy cable entry.
- Optional wall mounting brackets for certain sizes.

#### Stress relief

Acme uses strip conductors (above 7.5 kVA) instead of wire for a DIT series that easily accommodates the severe electrical and mechanical stresses found in today's AC & DC motor drives. The inherent excellent line isolation of these transformers is further enhanced with the extra protection of Acme's Electrostatic Shield — free in all DIT's.

#### Lower losses

The harmonic currents generated by AC & DC drives increase eddy current losses (heat) in transformer windings. The thicker the winding conductor, the greater the losses. Acme uses one turn per layer of thin strip conductor which provides lower eddy current losses than comparable wire wound units. Lower losses = cooler operation and longer transformer life.

#### Reduced short circuit forces

Strip windings minimize axial short circuit forces that can cause mechanical displacement of the windings under fault conditions. For extra protection all designs 7.5 kVA and above use primary and secondary coils of equal axial length. This feature tends to negate axial short circuit forces, further improving transformer life expectancy.

#### Selection instructions

If you know the motor horse-power, simply follow the drive system manufacturer's recommendation.

Or, select the corresponding kVA from the chart on the right.

For example, a 40 Hp motor requires a 51 kVA DIT.



H.P.	kVA
5.0	7.5
7.5	11.0
10.0	14.0
15.0	20.0
20.0	27.0
25.0	34.0
30.0	40.0
40.0	51.0
50.0	63.0
60.0	75.0
75.0	93.0
100.0	118.0
125.0	145.0
150.0	175.0
200.0	220.0
250.0	275.0
300.0	330.0
400.0	440.0
500.0	550.0
600.0	660.0

### ACME ADVANTAGE

#### Wound Cores and Strip Winding mean lower losses

All Acme DITs above 7.5 kVA are wound with strip windings to ensure the lowest possible eddy current losses. All our DITs 440 kVA and larger use stacked core. This superior design has very low losses and quiet operation. Both of these features combine to significantly reduce losses and operating costs compared to other types of constructions.

#### Copper terminations provide trouble-free operation

All Acme DITs up to and including 220 kVA have copper terminations. The transition from aluminum strip coil conductors to copper terminations is accomplished by a bonding process known as “Koldwelding™”. This process has been used by Acme for over 25 years to provide a trouble-free, permanent bonding of the two metals.

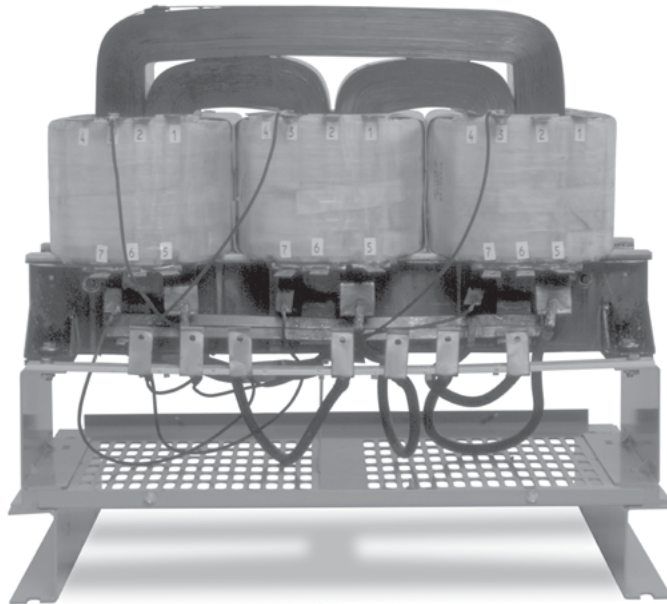

Wound core construction showing all copper terminations





kVA	Primary 230V Delta Secondary 230Y/133 Catalog Number	Height <sup>③</sup> (Inches)(Cm.)	Width <sup>③</sup> (Inches)(Cm.)	Depth <sup>③</sup> (Inches)(Cm.)	Weight (Lbs.)(Kg.)	Mounting Type (Wall)(Floor)	Weather Shield	Design Figures
7.5	DTFA72S (62)	15.21 (38.6)	19.25 (48.9)	7.37 (18.7)	180 (81.6)	W	NA	F
11.0	DTFA0112S	18.86 (48.0)	20.30 (51.6)	9.03 (22.9)	265 (120.0)	F ①	NA	I
14.0	DTFA0142S	18.86 (48.0)	20.30 (51.6)	9.03 (22.9)	265 (120.0)	F ①	NA	I
20.0	DTFA0202S	20.77 (52.8)	20.94 (53.2)	10.18 (25.9)	435 (197.0)	F ①	NA	I
27.0	DTFA0274S (59)	25.48 (64.8)	24.39 (62.0)	19.40 (49.3)	302 (137.0)	F ②	WSA1	E
34.0	DTFA0344S	25.48 (64.8)	24.39 (62.0)	19.40 (49.3)	330 (150.0)	F ②	WSA1	E
40.0	DTFA0404S	25.48 (64.8)	24.39 (62.0)	19.40 (49.3)	370 (168.0)	F ②	WSA1	E
51.0	DTFA0514S	29.40 (74.7)	28.15 (71.5)	22.40 (56.9)	375 (170.0)	F ②	WSA2	E
63.0	DTFA0634S	29.40 (74.7)	28.15 (71.5)	22.40 (56.9)	495 (225.0)	F ②	WSA2	E
75.0	DTFA0754S	29.40 (74.7)	28.15 (71.5)	22.40 (56.9)	525 (238.0)	F ②	WSA2	E
93.0	DTFA0934S	35.40 (89.9)	31.90 (81.0)	26.90 (68.3)	685 (311.0)	F	WSA3	E
118.0	DTFA01184S	35.40 (89.9)	31.90 (81.0)	26.90 (68.3)	710 (322.0)	F	WSA3	E
145.0	DTFA01454S	41.52 (105.5)	32.90 (83.6)	29.90 (75.9)	980 (445.0)	F	WSA4	E
175.0	DTFA01754S	41.52 (105.5)	32.90 (83.6)	29.90 (75.9)	1110 (504.0)	F	WSA4	E
220.0	DTFA02204S	41.52 (105.5)	32.90 (83.6)	29.90 (75.9)	1120 (508.0)	F	WSA4	E

① Optional wall mounting kits – part # PL 79911 refer to page 14.

② Optional wall mounting kits – part # PL 79912 refer to page 14.

The number in ( )'s following the catalog number is the electrical wiring diagram number beginning on page 13.

kVA	Primary 460V Delta Secondary 230Y/133 Catalog Number	Primary 460V Delta Secondary 460Y/266 Catalog Number	Height <sup>③</sup> (Inches)(Cm.)	Width <sup>③</sup> (Inches)(Cm.)	Depth <sup>③</sup> (Inches)(Cm.)	Weight (Lbs.)(Kg.)	Mounting Type (Wall)(Floor)	Weather Shield	Design Figures
7.5	DTGA72S (37)	DTGB72S (34)	15.21 (38.6)	19.25 (48.9)	7.37 (18.7)	180 (81.6)	W	NA	F
11.0	DTGA0112S	DTGB0112S	18.86 (47.9)	20.30 (51.6)	9.03 (22.9)	265 (120.0)	F ①	NA	I
14.0	DTGA0142S	DTGB0142S	18.86 (47.9)	20.30 (51.6)	9.03 (22.9)	270 (123.0)	F ①	NA	I
20.0	DTGA0202S	DTGB0202S	20.77 (52.8)	20.94 (53.2)	10.18 (25.9)	435 (197.0)	F ①	NA	I
27.0	DTGA0274S (38)	DTGB0274S (35)	25.50 (64.8)	24.39 (61.9)	19.37 (49.2)	320 (145.0)	F ②	WSA1	E
34.0	DTGA0344S	DTGB0344S	25.50 (64.8)	24.39 (61.9)	19.37 (49.2)	340 (154.0)	F ②	WSA1	E
40.0	DTGA0404S	DTGB0404S	25.50 (64.8)	24.39 (61.9)	19.37 (49.2)	395 (179.0)	F ②	WSA1	E
51.0	DTGA0514S	DTGB0514S	29.90 (75.9)	28.15 (71.5)	22.37 (56.8)	400 (181.0)	F ②	WSA2	E
63.0	DTGA0634S	DTGB0634S	29.90 (75.9)	28.15 (71.5)	22.37 (56.8)	550 (250.0)	F ②	WSA2	E
75.0	DTGA0754S	DTGB0754S	29.90 (75.9)	28.15 (71.5)	22.37 (56.8)	570 (259.0)	F ②	WSA2	E
93.0	DTGA0934S	DTGB0934S	35.90 (91.2)	31.90 (81.0)	26.88 (68.3)	685 (311.0)	F	WSA3	E
118.0	DTGA01184S	DTGB01184S	35.90 (91.2)	31.90 (81.0)	26.88 (68.3)	765 (347.0)	F	WSA3	E
145.0	DTGA01454S	DTGB01454S	41.52 (105.5)	32.90 (83.6)	29.88 (75.9)	990 (449.0)	F	WSA4	E
175.0	DTGA01754S	DTGB01754S	41.52 (105.5)	32.90 (83.6)	29.88 (75.9)	1100 (499.0)	F	WSA4	E
220.0	DTGA02204S	DTGB02204S	41.52 (105.5)	32.90 (83.6)	29.88 (75.9)	1120 (508.0)	F	WSA4	E
275.0	DTGA002754S	DTGB002754S	45.60 (115.8)	39.50 (100.3)	35.50 (90.2)	2090 (948.0)	F	WSA5	E
330.0	DTGA03304S	DTGB03304S	45.60 (115.8)	39.50 (100.3)	35.50 (90.2)	2090 (948.0)	F	WSA5	G
440.0		DTGB04404S	57.84 (146.9)	45.50 (115.6)	41.49 (105.4)	2295 (1043.2)	F	WSA7	G
550.0		DTGB05504S	57.84 (146.9)	45.50 (115.6)	41.49 (105.4)	2580 (1172.7)	F	WSA7	G
660.0		DTGB06604S	62.84 (159.6)	54.00 (137.2)	41.49 (105.4)	3700 (1678.3)	F	WSA6	G
770.0		DTGB07704S	62.84 (159.6)	54.00 (137.2)	41.49 (105.4)	4044 (1838.2)	F	WSA6	G
880.0		DTGB008804S	62.84 (159.6)	54.00 (137.2)	41.49 (105.4)	4230 (1922.7)	F	WSA6	G
990.0		DTGB9902S	62.84 (159.6)	54.00 (137.2)	41.49 (105.4)	4285 (1947.7)	F	WSA6	G

① Optional wall mounting kits-part # PL79911, refer to page 14.

② Optional wall mounting kits-part # PL79912, refer to page 14.

③ Dimensions may change and are not to be used for detailed construction purposes. Please contact the factory for certified dimensional drawings.

The number in ( )'s following the catalog number is the electrical wiring diagram number beginning on page 13.





kVA	Primary 575V Delta Secondary 230Y/133 Catalog Number	Primary 575V Delta Secondary 460Y/266 Catalog Number	Height <sup>③</sup> (Inches)(Cm.)	Width <sup>③</sup> (Inches)(Cm.)	Depth <sup>③</sup> (Inches)(Cm.)	Weight (Lbs.)(Kg.)	Mounting Type (Wall)(Floor)	Weather Shield	Design Figures
7.5	DTHA72S	(40) DTHB72S	(43) 15.21 (38.6)	19.25 (48.9)	7.37 (18.7)	180 (81.6)	W	NA	F
11.0	DTHA0112S	DTHB0112S	18.86 (47.9)	20.30 (51.6)	9.03 (22.9)	265 (120.0)	F ①	NA	I
14.0	DTHA0142S	DTHB0142S	18.86 (47.9)	20.30 (51.6)	9.03 (22.9)	270 (123.0)	F ①	NA	I
20.0	DTHA0202S	DTHB0202S	20.77 (52.8)	20.94 (53.2)	10.18 (25.9)	435 (197.0)	F ①	NA	I
27.0	DTHA0274S	(41) DTHB0274S	(44) 25.50 (64.8)	24.39 (61.9)	19.37 (49.2)	320 (145.0)	F ②	WSA1	E
34.0	DTHA0344S	DTHB0344S	25.50 (64.8)	24.39 (61.9)	19.37 (49.2)	340 (154.0)	F ②	WSA1	E
40.0	DTHA0404S	DTHB0404S	25.50 (64.8)	24.39 (61.9)	19.37 (49.2)	395 (179.0)	F ②	WSA1	E
51.0	DTHA0514S	DTHB0514S	29.90 (75.9)	28.15 (71.5)	22.37 (56.8)	400 (181.0)	F ②	WSA2	E
63.0	DTHA0634S	DTHB0634S	29.90 (75.9)	28.15 (71.5)	22.37 (56.8)	550 (250.0)	F ②	WSA2	E
75.0	DTHA0754S	DTHB0754S	29.90 (75.9)	28.15 (71.5)	22.37 (56.8)	570 (259.0)	F ②	WSA2	E
93.0	DTHA0934S	DTHB0934S	35.90 (91.2)	31.90 (81.0)	26.88 (68.3)	685 (311.0)	F	WSA3	E
118.0	DTHA01184S	DTHB01184S	35.90 (91.2)	31.90 (81.0)	26.88 (68.3)	765 (347.0)	F	WSA3	E
145.0	DTHA01454S	DTHB01454S	41.52 (105.5)	32.90 (83.6)	29.88 (75.9)	990 (449.0)	F	WSA4	E
175.0		DTHB01754S	41.52 (105.5)	32.90 (83.6)	29.88 (75.9)	1100 (499.0)	F	WSA4	E
220.0		DTHB02204S	41.52 (105.5)	32.90 (83.6)	29.88 (75.9)	1120 (508.0)	F	WSA4	E
275.0		DTHB02754S	45.60 (115.8)	39.50 (100.3)	35.50 (90.2)	2090 (948.0)	F	WSA5	E
330.0		DTHB03304S	45.60 (115.8)	39.50 (100.3)	35.50 (90.2)	2090 (948.0)	F	WSA5	G
440.0		DTHB04404S	57.84 (157.5)	45.50 (115.6)	41.49 (105.4)	2580 (1172.7)	F	WSA7	G
550.0		DTHB05504S	57.84 (157.5)	45.50 (115.6)	41.49 (105.4)	2640 (1200.0)	F	WSA7	G
660.0		DTHB06604S	62.84 (159.6)	54.00 (137.2)	41.49 (105.4)	3700 (1678.3)	F	WSA6	G

① Optional wall mounting kits-part # PL79911, refer to page 14.

② Optional wall mounting kits-part # PL79912, refer to page 14.

③ Dimensions may change and are not to be used for detailed construction purposes. Please contact the factory for certified dimensional drawings.

The number in ( )'s following the catalog number is the electrical wiring diagram number beginning on page13.

### Windings, Terminals and Construction

kVA	Primary Winding	Secondary Winding	Insulation System	Termination	Enclosure	Construction	Core
7.5	CU wire	CU wire	180°C	CU wire	Epoxy encapsulated		Wound/distributed gap
11-20	AL foil	AL foil	180°C	CU wire	Epoxy encapsulated		Wound/distributed gap
27-220	AL foil	AL foil	220°C	CU bus	Ventilated		Wound/distributed gap
275-330	AL foil	AL foil	220°C	AL bus	Ventilated		Wound/distributed gap
440-770	AL foil	AL foil	220°C	AL bus	Ventilated		Butt stacked/Step lap

### Thermal Switch Kit - PL-79900

Acme Thermal Switch Kits are designed for use with single and three phase drive isolation and distribution transformers. Thermal switch kits are available for a one or three sensor system.

Thermal sensors can be field installed in the transformer winding ducts to detect abnormal temperatures. The thermal sensors are a normally closed contact that opens at 200°C ± 10°C and has a current capacity of 5 amps @ 120V or 2.5 amps @ 240V. This contact can activate any number of different types of alarms or mechanisms that could warn of a potential failure.



## Section 4 | General Description and Features

kVA	Mounting Position	Illustration
270-118.0	Bottom of the case	Figure 1
145-750	Top flange of the core bracket	Figure 2

**For Information on the following, please contact the factory**

1. Transformers rated primary 230 volts delta, secondary 460Y/266 volts.
2. Low temperature rise units using class 220°C insulation with either 115°C or 80°C rise operating temperature.
3. Totally enclosed non-ventilated units.

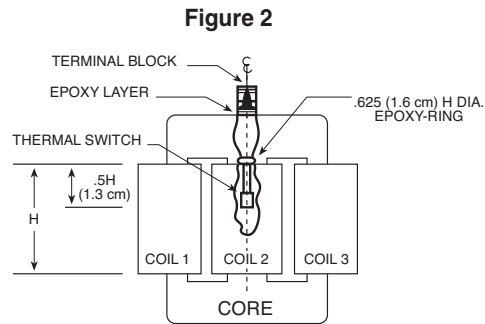
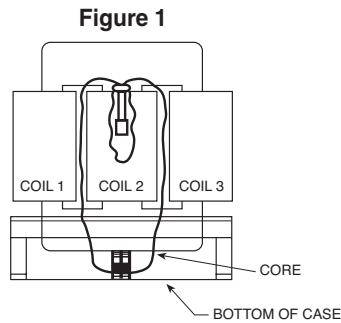

### AC LINE REACTORS

Protect your sensitive equipment from harmful line disturbances with Acme AC Line Reactors. AC Line Reactors help prevent equipment failure and downtime, and can add years to the life of your equipment.

Designed to protect DC motor drives, AC variable frequency drives and the motors they power. AC Line Reactors allow Acme to augment the Drive Isolation Transformer package to offer both line and load power quality protection for a wide range of applications.

Our product line features flexible design and ease of installation for use in a variety of applications such as paper machines, process lines, press controls and drive systems, along with tube mills and other sophisticated process equipment. These applications are found in such industries as food and beverage, paper, packaging systems and printing.

### Features

- Gapped iron core inductor—designed for optimum performance while providing harmonics compensation.
- Precision wound copper coils—maximum protection from short-circuiting.
- Finger-safe terminal blocks (up to 60 HP).
- Compact design—allows for more flexible installation.
- Amperage ratings of 2 to 600 amps
- Available in 3% and 5% impedance
- Can be used with 208, 240, 480 and 600 volts.
- Covered under Acme's 10-year limited warranty.
- UR and cUR Recognized.
- CE Marked (up to 55 amps)

### Benefits

Protect your motors and motor drives from a variety of power conditioning problems while realizing the following benefits:

- Protection from damaging voltage drop.
- Elimination of nuisance tripping of drives or circuit breakers.
- Reduction of motor current surges and power line spike currents.
- Improvement in true power factor of capacitor input drives.
- Cooler, quieter operation.
- Reduction of harmonic distortion.
- Longer life for motors and solid state components.



### AC Line Reactors Dimensional Drawings

1-60 HP; 2-80 Amp

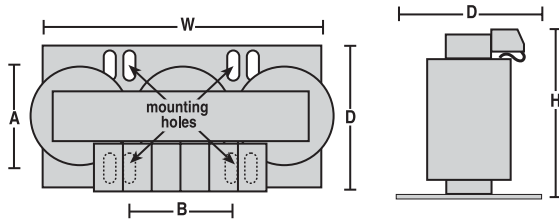

75-500 HP; 110-600 Amp

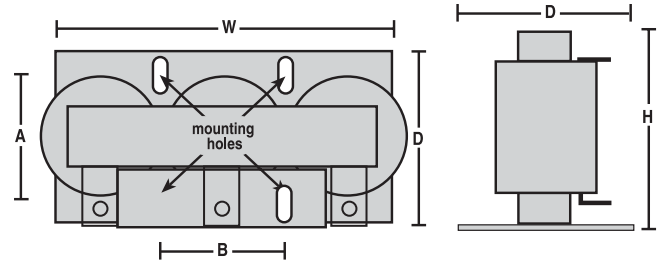

### APPLYING AC LINE REACTORS

Acme's three-phase AC Line Reactors can be used as an input filter for adjustable speed DC drives and as input or output filters for AC pulse width modulated variable frequency drives. They are bi-directional protective filtering devices and can be applied in a variety of configurations.

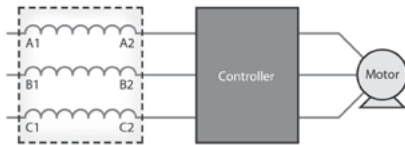

#### Input to Inverter/Drive

AC Line Reactors protect your sensitive equipment from noise generated by the drive or inverter. They protect the controller from power surges, spikes and harmonic distortion.

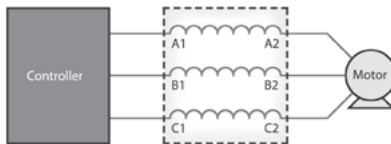

#### Output of Inverter/Drive (AC Drive only)

Motors run cooler and quieter with an AC Line Reactor placed between the inverter and motor. This application also reduces dv/dt and protects the controller from short circuits and surges.

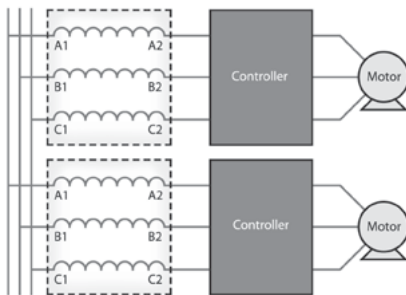

#### Multiple Controllers on a Single Power Line

Each drive or inverter on a single power line requires its own AC Line Reactor in order to provide adequate surge protection, prevent crosstalk and reduce harmonic distortion.

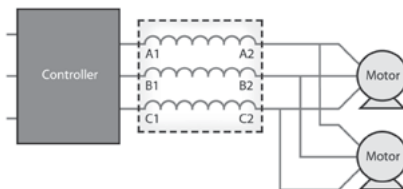

#### Multiple Motors Controlled by a Single Drive (AC Drive only)

Multiple motors controlled by a single drive require only one AC Line Reactor between the controller and motors.



480 VOLTS, 3% Z, 60 Hz (600 VOLTS, 2.4% Z; 240 VOLTS, 6% Z)

Catalog Number	Motor*				Dimensions			Mounting Dimensions		Weight (Lbs.)(Kg.)
	H.P.	Amp	Reactor Amp	uH	Height (Inches)(Cm.)	Width (Inches)(Cm.)	Depth (Inches)(Cm.)	A (Depth)	B (Width)	
ALRB002TBC ①	1	2.1	2	11027	3.875 (9.8)	4.25 (10.8)	3.125 (7.90)	2.00 (5.1)	1.44 (3.7)	3 (1.4)
ALRB003TBC ①	1.5	3	3	7351	3.875 (9.8)	4.25 (10.8)	3.125 (7.90)	2.00 (5.1)	1.44 (3.7)	3 (1.4)
ALRB004TBC ①	2	3.4	4	5513	3.875 (9.8)	4.25 (10.8)	3.125 (7.90)	2.00 (5.1)	1.44 (3.7)	3 (1.4)
ALRB006TBC ①	3	4.8	6	3676	3.875 (9.8)	4.25 (10.8)	3.125 (7.90)	2.00 (5.1)	1.44 (3.7)	3 (1.4)
ALRB008TBC ①	5	7.6	8	2757	4.75 (12.1)	6.50 (16.5)	3.75 (9.50)	2.10 (5.3)	2.00 (5.1)	5 (2.3)
ALRB012TBC ①	7.5	11	12	1838	4.75 (12.1)	6.50 (16.5)	3.75 (9.50)	2.10 (5.3)	2.00 (5.1)	6 (2.7)
ALRB016TBC ①	10	14	16	1378	4.75 (12.1)	6.50 (16.5)	3.75 (9.50)	2.30 (5.8)	2.00 (5.1)	6 (2.7)
ALRB025TBC ①	15	21	25	882	4.75 (12.1)	6.50 (16.5)	4.00 (10.2)	2.60 (6.6)	2.50 (6.4)	9 (4.1)
ALRB027TBC ①	20	27	27	817	4.75 (12.1)	6.50 (16.5)	4.00 (10.2)	2.60 (6.6)	2.50 (6.4)	9 (4.1)
ALRB035TBC ①	25	34	35	630	4.75 (12.1)	6.50 (16.5)	4.50 (11.4)	3.20 (8.1)	2.50 (6.4)	13 (5.9)
ALRB045TBC ①	30	40	45	490	4.75 (12.1)	6.50 (16.5)	4.50 (11.4)	3.20 (8.1)	3.00 (7.6)	14 (6.4)
ALRB055TBC ①	40	52	55	401	7.00 (17.8)	9.00 (22.9)	4.50 (11.4)	3.50 (8.9)	3.60 (9.1)	22 (10.0)
ALRB080TBC	60	77	80	276	7.00 (17.8)	9.00 (22.9)	4.75 (12.1)	3.60 (9.1)	3.60 (9.1)	23 (10.4)
ALRB110CBC	75	96	110	200	7.00 (17.8)	9.00 (22.9)	5.50 (14.0)	3.60 (9.1)	3.60 (9.1)	27 (12.2)
ALRB130CBC	100	124	130	170	7.00 (17.8)	9.00 (22.9)	6.50 (16.5)	3.50 (8.9)	3.60 (9.1)	34 (15.4)
ALRB160CBC	125	156	160	138	7.00 (17.8)	9.00 (22.9)	6.50 (16.5)	4.20 (10.7)	3.60 (9.1)	36 (16.3)
ALRB200CBC	150	180	200	110	7.00 (17.8)	9.00 (22.9)	8.00 (20.3)	4.20 (10.7)	3.60 (9.1)	55 (24.9)
ALRB250CBC	200	240	250	88	8.50 (21.6)	10.80 (27.4)	8.00 (20.3)	5.70 (14.5)	4.60 (11.7)	74 (33.6)
ALRB300CBC	250	302	300	74	8.50 (21.6)	10.80 (27.4)	8.00 (20.3)	5.20 (13.2)	4.60 (11.7)	85 (38.6)
ALRB360CBC	300	361	360	61	8.50 (21.6)	10.80 (27.4)	8.00 (20.3)	6.20 (15.2)	4.60 (11.7)	105 (47.6)
ALRB420CBC	350	414	420	53	8.50 (21.6)	10.80 (27.4)	8.50 (21.6)	6.20 (15.2)	4.60 (11.7)	113 (51.3)
ALRB480CBC	400	477	480	46	8.50 (21.6)	10.80 (27.4)	8.50 (21.6)	6.70 (17.0)	4.60 (11.7)	119 (54.0)

\* Motor HP and Amp rated at 480 volts.

① CE Marked





480 VOLTS, 5% Z, 60 Hz (600 VOLTS, 4% Z; 240 VOLTS, 10% Z)

Catalog Number	Motor*				Dimensions			Mounting Dimensions		Weight (Lbs.)(Kg.)
	H.P.	Amp	Reactor Amp	uH	Height (Inches)(Cm.)	Width (Inches)(Cm.)	Depth (Inches)(Cm.)	A (Depth)	B (Width)	
ALRC002TBC ①	1	2.1	2	18378	3.875 (9.8)	4.25 (10.8)	3.125 (7.9)	2.00 (5.1)	1.44 (3.7)	3 (1.4)
ALRC003TBC ①	1.5	3	3	12252	3.875 (9.8)	4.25 (10.8)	3.125 (7.9)	2.00 (5.1)	1.44 (3.7)	3 (1.4)
ALRC004TBC ①	2	3.4	4	9189	3.875 (9.8)	4.25 (10.8)	3.125 (7.9)	2.10 (5.3)	1.44 (3.7)	4 (1.8)
ALRC006TBC ①	3	4.8	6	6126	4.75 (12.1)	6.50 (16.5)	3.75 (9.5)	2.10 (5.3)	2.00 (5.1)	5 (2.3)
ALRC008TBC ①	5	7.6	8	4594	4.75 (12.1)	6.50 (16.5)	3.75 (9.5)	2.10 (5.3)	2.00 (5.1)	6 (2.7)
ALRC012TBC ①	7.5	11	12	3063	4.75 (12.1)	6.50 (16.5)	3.75 (9.5)	2.20 (5.6)	2.00 (5.1)	7 (3.2)
ALRC016TBC ①	10	14	16	2297	4.75 (12.1)	6.50 (16.5)	4.00 (10.2)	2.60 (6.6)	2.00 (5.1)	9 (4.1)
ALRC025TBC ①	15	21	25	1470	4.75 (12.1)	6.50 (16.5)	4.50 (11.4)	3.00 (7.6)	2.00 (5.1)	13 (5.9)
ALRC027TBC ①	20	27	27	1361	4.75 (12.1)	6.50 (16.5)	4.50 (11.4)	2.80 (7.1)	3.00 (7.6)	13 (5.9)
ALRC035TBC ①	25	34	35	1050	7.00 (17.8)	9.00 (22.9)	4.75 (12.1)	3.60 (9.1)	3.00 (7.6)	23 (10.4)
ALRC045TBC ①	30	40	45	817	7.00 (17.8)	9.00 (22.9)	4.75 (12.1)	3.60 (9.1)	3.00 (7.6)	23 (10.4)
ALRC055TBC ①	40	52	55	668	7.00 (17.8)	9.00 (22.9)	4.75 (12.1)	3.60 (9.1)	3.00 (7.6)	24 (10.9)
ALRC080TBC	60	77	80	459	7.00 (17.8)	9.00 (22.9)	5.75 (14.6)	4.60 (11.7)	3.60 (9.1)	34 (15.4)
ALRC110CBC	75	96	110	334	7.00 (17.8)	9.00 (22.9)	6.50 (16.5)	4.20 (10.7)	3.60 (9.1)	56 (25.4)
ALRC130CBC	100	124	130	283	7.00 (17.8)	9.00 (22.9)	6.50 (16.5)	4.20 (10.7)	3.60 (9.1)	56 (25.4)
ALRC160CBC	125	156	160	230	7.00 (17.8)	9.00 (22.9)	8.00 (20.3)	4.20 (10.7)	3.60 (9.1)	70 (31.8)
ALRC200CBC	150	180	200	184	8.50 (21.6)	10.80 (27.4)	8.25 (21.0)	5.90 (15.0)	3.60 (9.1)	76 (34.5)
ALRC250CBC	200	240	250	147	8.50 (21.6)	10.80 (27.4)	8.25 (21.0)	6.20 (15.7)	4.60 (11.7)	89 (40.4)
ALRC300CBC	250	302	300	123	10.93 (27.8)	16.50 (41.9)	8.13 (20.7)	6.20 (15.7)	4.60 (11.7)	106 (48.1)
ALRC360CBC	300	361	360	102	10.93 (27.8)	16.50 (41.9)	9.50 (24.1)	8.20 (20.8)	4.60 (11.7)	124 (56.2)
ALRC420CBC	350	414	420	88	10.93 (27.8)	16.50 (41.9)	9.50 (24.1)	8.20 (20.8)	4.60 (11.7)	124 (56.2)
ALRC480CBC	400	477	480	77	10.93 (27.8)	16.50 (41.9)	10.13 (25.7)	8.20 (20.8)	4.60 (11.7)	129 (58.5)
ALRC600CBC	500	590	600	61	10.93 (27.8)	16.50 (41.9)	10.13 (25.7)	8.20 (20.8)	7.20 (18.3)	190 (86.2)

\* Motor HP and Amp rated at 480 volts.

① CE Marked



## Section 4 | Encapsulated Selection Guide

### ENCAPSULATED LINE REACTORS



Acme's Encapsulated AC Line Reactors are designed to protect DC motor drives and AC variable frequency drives or motors— with one important difference. These line reactors are completely enclosed, so the unit can be mounted outside the control panel.

Ideal for applications such as process lines, paper machines, casters, tube mills, tire assembly, laminators, press controls and drive systems. Acme's Encapsulated AC Line Reactors immerse the core and coil assembly in an electrical grade silica and resin compound that seals out moisture and potential corrosives. These Line Reactors are housed in a NEMA 3R Enclosure suitable for indoor or outdoor applications. What's more, these encapsulated line reactors are extremely convenient to install. They can be floor or wall mounted and front access makes wiring easy.

#### Features

- UL Type 3R enclosure.
- Available with stainless steel enclosure.
- Versatile mounting options to meet special application requirements.
- Large wiring compartment remains cool.
- No conduit or pull boxes needed.
- Front access to compartment simplifies wiring.
- Flexible copper leadwire terminates outside wiring compartment for quick connections.
- Dual-size knockouts in both sides and bottom of compartment for added flexibility in wiring.
- Ground studs for use with non-metallic conduit.
- UL and cUL Listed, CE Marked.
- Backed by Acme's 10-year limited warranty

#### Benefits

- Completely enclosed design provides protection against corrosion and insulation deterioration in washdown and harsh environment.
- Easy to install and wire.
- Protects against a whole range of power conditioning problems.
- Eliminates motor failure due to poor power quality.
- Reduces downtime.
- Extends the life of your equipment.





### 480 VOLTS, 3% Z, 60 Hz (600 VOLTS, 2.4% Z; 240 VOLTS, 6% Z)

Catalog Number	Motor*				Dimensions			Design Figures	Weight (Lbs.)(Kg.)
	H.P.	Amp	Reactor Amp	uH	Height (Inches)(Cm.)	Width (Inches)(Cm.)	Depth (Inches)(Cm.)		
ALRB002LWE	1	2.1	2	11027	9.68 (24.6)	4.75 (12.1)	4.5 (11.4)	A	10 (4.5)
ALRB003LWE	1.5	3	3	7351	9.68 (24.6)	4.75 (12.1)	4.5 (11.4)	A	10 (4.5)
ALRB004LWE	2	3.4	4	5513	9.68 (24.6)	4.75 (12.1)	4.5 (11.4)	A	10 (4.5)
ALRB006LWE	3	4.8	6	3676	9.68 (24.6)	4.75 (12.1)	4.5 (11.4)	A	10 (4.5)
ALRB008LWE	5	7.6	8	2757	11.5 (29.2)	10.31 (26.2)	7.13 (18.1)	B	24 (10.9)
ALRB012LWE	7.5	11	12	1838	11.5 (29.2)	10.31 (26.2)	7.13 (18.1)	B	24 (10.9)
ALRB016LWE	10	14	16	1378	11.5 (29.2)	10.31 (26.2)	7.13 (18.1)	B	25 (11.3)
ALRB025LWE	15	21	25	882	11.5 (29.2)	10.31 (26.2)	7.13 (18.1)	B	28 (12.7)
ALRB027LWE	20	27	27	817	11.5 (29.2)	10.31 (26.2)	7.13 (18.1)	B	28 (12.7)
ALRB035LWE	25	34	35	630	11.5 (29.2)	10.31 (26.2)	7.13 (18.1)	B	32 (14.5)
ALRB045LWE	30	40	45	490	11.5 (29.2)	10.31 (26.2)	7.13 (18.1)	B	33 (15.0)
ALRB055LWE	40	52	55	401	11.83 (30.0)	14.17 (36.0)	8.82 (22.4)	C	73 (33.1)
ALRB080LWE	60	77	80	276	11.83 (30.0)	14.17 (36.0)	8.82 (22.4)	C	75 (34.0)
ALRB110LWE	75	96	110	200	11.83 (30.0)	14.17 (36.0)	8.82 (22.4)	C	78 (35.4)
ALRB130LWE	100	124	130	170	11.83 (30.0)	14.17 (36.0)	8.82 (22.4)	C	85 (38.6)
ALRB160LWE	125	156	160	138	11.83 (30.0)	14.17 (36.0)	8.82 (22.4)	C	87 (39.5)

\* Motor HP and Amp rated at 480 volts.

### 480 VOLTS, 5% Z, 60 Hz (600 VOLTS, 4% Z; 240 VOLTS, 10% Z)

Catalog Number	Motor*				Dimensions			Design Figures	Weight (Lbs.)(Kg.)
	H.P.	Amp	Reactor Amp	uH	Height (Inches)(Cm.)	Width (Inches)(Cm.)	Depth (Inches)(Cm.)		
ALRC002LWE	1	2.1	2	18378	9.68 (24.6)	4.75 (12.1)	4.5 (11.4)	A	10 (4.5)
ALRC003LWE	1.5	3	3	12252	9.68 (24.6)	4.75 (12.1)	4.5 (11.4)	A	10 (4.5)
ALRC004LWE	2	3.4	4	9189	9.68 (24.6)	4.75 (12.1)	4.5 (11.4)	A	10 (4.5)
ALRC006LWE	3	4.8	6	6126	11.5 (29.2)	10.31 (26.2)	7.13 (18.1)	B	24 (10.9)
ALRC008LWE	5	7.6	8	4594	11.5 (29.2)	10.31 (26.2)	7.13 (18.1)	B	24 (10.9)
ALRC012LWE	7.5	11	12	3063	11.5 (29.2)	10.31 (26.2)	7.13 (18.1)	B	26 (11.8)
ALRC016LWE	10	14	16	2297	11.5 (29.2)	10.31 (26.2)	7.13 (18.1)	B	28 (12.7)
ALRC025LWE	15	21	25	1470	11.5 (29.2)	10.31 (26.2)	7.13 (18.1)	B	32 (14.5)
ALRC027LWE	20	27	27	1361	11.5 (29.2)	10.31 (26.2)	7.13 (18.1)	B	32 (14.5)
ALRC035LWE	25	34	35	1050	11.83 (30.0)	14.17 (36.0)	8.82 (22.4)	C	74 (33.6)
ALRC045LWE	30	40	45	817	11.83 (30.0)	14.17 (36.0)	8.82 (22.4)	C	75 (34.0)
ALRC055LWE	40	52	55	668	11.83 (30.0)	14.17 (36.0)	8.82 (22.4)	C	75 (34.0)
ALRC080LWE	60	77	80	459	11.83 (30.0)	14.17 (36.0)	8.82 (22.4)	C	85 (38.6)
ALRC110LWE	75	96	110	334	11.83 (30.0)	14.17 (36.0)	8.82 (22.4)	C	107 (48.5)
ALRC130LWE	100	124	130	263	11.83 (30.0)	14.17 (36.0)	8.82 (22.4)	C	107 (48.5)
ALRC160LWE	125	156	160	230	11.83 (30.0)	14.17 (36.0)	8.82 (22.4)	C	121 (54.9)

\* Motor HP and Amp rated at 480 volts.

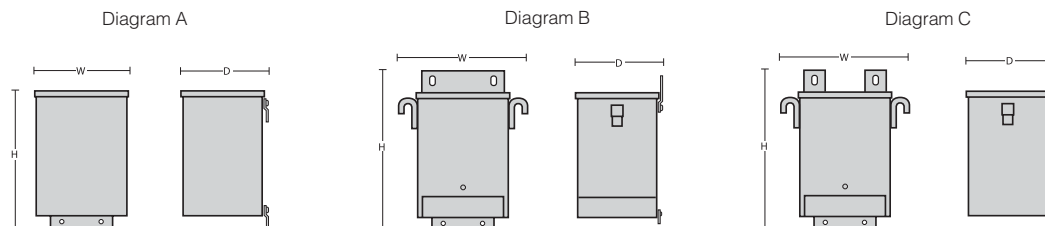

## Section 4 | Wiring Diagrams

**34** PRIMARY: 460 Volts Delta  
SECONDARY: 460Y/266 Volts  
TAPS: 1-5% ANFC and BNFC

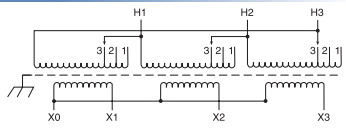

Primary Volts	%	Connect Leads to Tap No.
483	105	1
460	100	2
437	95	3
Secondary Volts		
460		X1, X2, X3
266 1 phase		X1 & X0, X2 & X0 X3 & X0

**35** PRIMARY: 460 Volts Delta  
SECONDARY: 460Y/266 Volts  
TAPS: 2-2 1/2% ANFC and BNFC

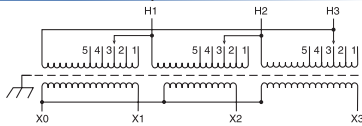

Primary Volts	%	Connect Leads to Tap No.
483	105	1
472	102.5	2
460	100	3
449	97.5	4
437	95	5
Secondary Volts		
460		X1, X2, X3
266 1 phase		X1 & X0, X2 & X0 X3 & X0

**37** PRIMARY: 460 Volts Delta  
SECONDARY: 230Y/133 Volts  
TAPS: 1-5% ANFC and BNFC

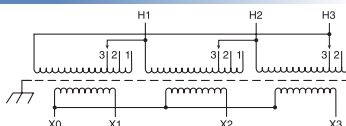

Primary Volts	%	Connect Leads to Tap No.
483	105	1
460	100	2
437	95	3
Secondary Volts		
230		X1, X2, X3
133 1 phase		X1 & X0, X2 & X0 X3 & X0

**38** PRIMARY: 460 Volts Delta  
SECONDARY: 230Y/133 Volts  
TAPS: 2-2 1/2% ANFC and BNFC

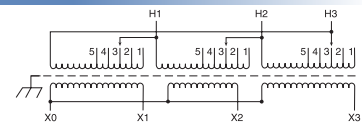

Primary Volts	%	Connect Leads to Tap No.
483	105	1
472	102.5	2
460	100	3
449	97.5	4
437	95	5
Secondary Volts		
230		X1, X2, X3
133 1 phase		X1 & X0, X2 & X0 X3 & X0

**40** PRIMARY: 575 Volts Delta  
SECONDARY: 230Y/133 Volts  
TAPS: 1-5% ANFC and BNFC

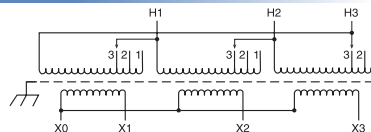

Primary Volts	%	Connect Leads to Tap No.
604	105	1
575	100	2
546	95	3
Secondary Volts		
230		X1, X2, X3
133 1 phase		X1 & X0 X2 & X0 X3 & X0

**41** PRIMARY: 575 Volts Delta  
SECONDARY: 230Y/133 Volts  
TAPS: 2-2 1/2% ANFC and BNFC

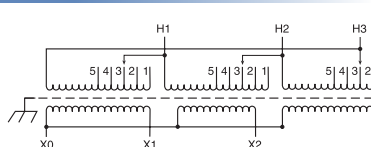

Primary Volts	%	Connect Leads to Tap No.
604	105	1
589	102.5	2
575	100	3
561	97.5	4
546	95	5
Secondary Volts		
230		X1, X2, X3
133 1 phase		X1 & X0 X2 & X0 X3 & X0

**43** PRIMARY: 575 Volts Delta  
SECONDARY: 460Y/266 Volts  
TAPS: 1-5% ANFC and BNFC

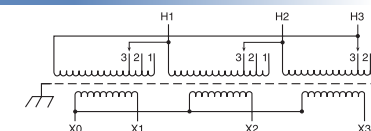

Primary Volts	%	Connect Leads to Tap No.
604	105	1
575	100	2
546	95	3
Secondary Volts		
460		X1, X2, X3
266 1 phase		X1 & X0 X2 & X0 X3 & X0

**44** PRIMARY: 575 Volts Delta  
SECONDARY: 460Y/266 Volts  
TAPS: 2-2 1/2% ANFC and BNFC

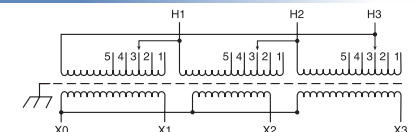

Primary Volts	%	Connect Leads to Tap No.
604	105	1
589	102.5	2
575	100	3
561	97.5	4
546	95	5
Secondary Volts		
460		X1, X2, X3
266 1 phase		X1 & X0 X2 & X0 X3 & X0

**59** PRIMARY: 230 Volts Delta  
SECONDARY: 230Y/133 Volts  
TAPS: 2-2 1/2% ANFC and 2-2 1/2% BNFC

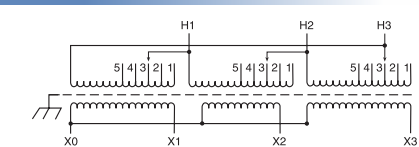

Primary Volts	%	Connect Leads to Tap No.
242	105	1
236	102.5	2
230	100	3
224	97.5	4
219	95	5
Secondary Volts		
230		X1, X2, X3
133 1 phase		X1 & X0 X2 & X0 X3 & X0

**62** PRIMARY: 230 Volts Delta  
SECONDARY: 230Y/133 Volts  
TAPS: 1-5% ANFC and 1-5% BNFC

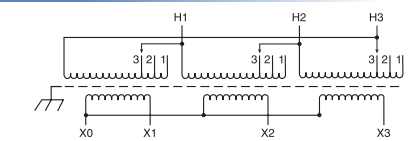

Primary Volts	%	Connect Leads to Tap No.
241	105	1
230	100	2
218	95	3
Secondary Volts		
230		X1, X2, X3
133 1 phase		X1 & X0 X2 & X0 X3 & X0



**WALL MOUNTING BRACKET**

Required on:  
Ventilated Units:  
3Ø, 27-75 kVA  
Catalog Number: PL-79912

Encapsulated Units:  
3Ø dit., 11 kVA — 20 kVA  
Catalog Number: PL-79911

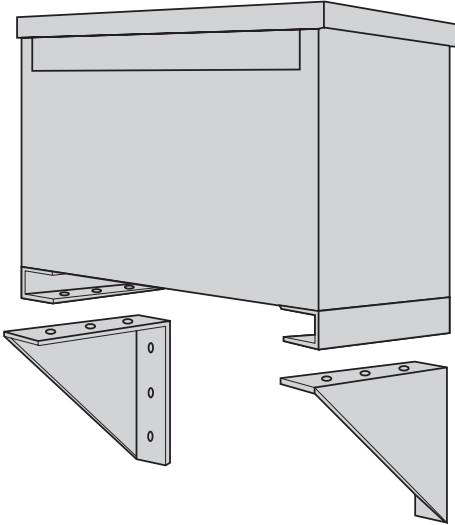

# Warranty Certificate

**Acme Electric 10-Year Limited\* Warranty**

Acme Electric (Acme) warrants to the original purchaser to correct by repair, replacement or refund of original purchase price, at Acme's option, products manufactured and sold by its Power Distribution Products Division, that may fail in service within the applicable period as set forth below, from the date of manufacture provided however, that conditions of operation have been normal at all times, and that the equipment has not been subjected to abnormal stress from such causes as incorrect primary voltage or frequency, improper ventilation or improper use. This warranty is made on the condition that prompt notice of defect is given to Acme in writing within the warranty period, and that Acme's inspection reveals to its satisfaction that the original purchaser's claim is valid under the terms of this warranty. Acme's obligation under this warranty, which is in lieu of all other warranties, express or implied, including the implied warranty of fitness for a particular purpose and merchantability, is limited to replacing or repairing defective products or parts, free of charge, provided they are returned to the factory, or refund of original purchase price, at Acme's option. However, purchased components (except for timers and photocells used in low voltage lighting power supplies) including but not limited to capacitors, circuit breakers, terminal blocks, batteries, fuses and tubes shall not be covered under this warranty. Repairs or replacement deliveries shall not interrupt or prolong the term of this warranty. Acme will not be liable for any special, indirect, consequential or incidental damages, including, without limitation, from loss of use, data, function or profits deriving out of or in connection with the use or performance of the product and shall have no liability for payment of any other damages whether in an action of contract, strict liability or tort. The remedy provided herein states Acme Electric's entire liability and buyer's sole and exclusive remedy here under. Rights may vary in certain states.

**\*Warranty Period:**  
 Standard Catalog Transformers — 10-year limited; Medium Voltage Transformer — 3-year limited, Custom products — 1 year.





ALRB002LWE	12	ALRB300CBC	9	ALRC160CBC	10	DTGA0344S	5	DTHA01454S	6
ALRB002TBC	9	ALRB360CBC	9	ALRC160LWE	12	DTGA0404S	5	DTHA0202S	6
ALRB003LWE	12	ALRB420CBC	9	ALRC200CBC	10	DTGA0514S	5	DTHA0274S	6
ALRB003TBC	9	ALRB480CBC	9	ALRC250CBC	10	DTGA0634S	5	DTHA0344S	6
ALRB004LWE	12	ALRC002LWE	12	ALRC300CBC	10	DTGA0754S	5	DTHA0404S	6
ALRB004TBC	9	ALRC002TBC	10	ALRC360CBC	10	DTGA0934S	5	DTHA0514S	6
ALRB006LWE	12	ALRC003LWE	12	ALRC420CBC	10	DTGA72S	5	DTHA0634S	6
ALRB006TBC	9	ALRC003TBC	10	ALRC480CBC	10	DTGB002754S	5	DTHA0754S	6
ALRB008LWE	12	ALRC004LWE	12	ALRC600CBC	10	DTGB008804S	5	DTHA0934S	6
ALRB008TBC	9	ALRC004TBC	10	DTFA0112S	5	DTGB0112S	5	DTHA72S	6
ALRB012LWE	12	ALRC006LWE	12	DTFA01184S	5	DTGB01184S	5	DTHB002754S	6
ALRB012TBC	9	ALRC006TBC	10	DTFA0142S	5	DTGB0142S	5	DTHB006604S	6
ALRB016LWE	12	ALRC008LWE	12	DTFA01454S	5	DTGB01454S	5	DTHB0112S	6
ALRB016TBC	9	ALRC008TBC	10	DTFA01754S	5	DTGB01754S	5	DTHB01184S	6
ALRB025LWE	12	ALRC012LWE	12	DTFA0202S	5	DTGB0202S	5	DTHB0142S	6
ALRB025TBC	9	ALRC012TBC	10	DTFA02204S	5	DTGB02204S	5	DTHB01454S	6
ALRB027LWE	12	ALRC016LWE	12	DTFA0274S	5	DTGB0274S	5	DTHB01754S	6
ALRB027TBC	9	ALRC016TBC	10	DTFA0344S	5	DTGB03304S	5	DTHB0202S	6
ALRB035LWE	12	ALRC025LWE	12	DTFA0404S	5	DTGB0344S	5	DTHB02204S	6
ALRB035TBC	9	ALRC025TBC	10	DTFA0514S	5	DTGB0404S	5	DTHB0274S	6
ALRB045LWE	12	ALRC027LWE	12	DTFA0634S	5	DTGB04404S	5	DTHB03304S	6
ALRB045TBC	9	ALRC027TBC	10	DTFA0754S	5	DTGB0514S	5	DTHB0344S	6
ALRB055LWE	12	ALRC035LWE	12	DTFA0934S	5	DTGB05504S	5	DTHB0404S	6
ALRB055TBC	9	ALRC035TBC	10	DTFA72S	5	DTGB0634S	5	DTHB04404S	6
ALRB080LWE	12	ALRC045LWE	12	DTGA0112S	5	DTGB06604S	5	DTHB0514S	6
ALRB080TBC	9	ALRC045TBC	10	DTGA01184S	5	DTGB0754S	5	DTHB05504S	6
ALRB110CBC	9	ALRC055LWE	12	DTGA0142S	5	DTGB07704S	5	DTHB0634S	6
ALRB110LWE	12	ALRC055TBC	10	DTGA01454S	5	DTGB0934S	5	DTHB0754S	6
ALRB130CBC	9	ALRC080LWE	12	DTGA01754S	5	DTGB72S	5	DTHB0934S	6
ALRB130LWE	12	ALRC080TBC	10	DTGA0202S	5	DTGB9902S	5	DTHB72S	6
ALRB160CBC	9	ALRC110CBC	10	DTGA02204S	5	DTHA0112S	6		
ALRB160LWE	12	ALRC110LWE	12	DTGA0274S	5	DTHA0112S	6		
ALRB200CBC	9	ALRC130CBC	10	DTGA02754S	5	DTHA01184S	6		
ALRB250CBC	9	ALRC130LWE	12	DTGA03304S	5	DTHA0142S	6		





*Our history is strong,  
engaging and dedicated...  
just like our people.*



### ***The Acme Electric Legacy***

Acme Electric provides power quality and conversion equipment to OEM, industrial and commercial markets. Founded in 1917 in Cleveland, Ohio as the Acme Electric and Machine Company, the company has a legacy of providing innovative electrical products. Acme is now part of Hubbell Incorporated, one of the largest electrical manufacturers in North America. Hubbell's history of innovation extends back to 1888 and the invention of the pull chain light switch and the electric plug.

Acme's original product line of motor-driven battery chargers, electrical appliances and electrical generators has transformed to a diversified mix of high-quality low voltage, medium voltage and 3 phase transformers and power supplies.

Learn more about us at [www.hubbell.com/acmeelectric/en](http://www.hubbell.com/acmeelectric/en)



**COMMERCIAL  
CONSTRUCTION**

A Division of Hubbell Incorporated (Delaware)

ACME ELECTRIC  
Menomonee Falls, WI 53051  
[www.hubbell.com/acmeelectric/en](http://www.hubbell.com/acmeelectric/en)  
800-334-5214



AE\_CAT\_4\_001  
3/2019