

PCEC Hydraulic Elevator Softstarters up to 150 HP @ 480 VAC

Unique advantages not found in electromechanical or other solid state starters

PCEC Hydraulic Elevator Softstarters



The PCE Hydraulic Elevator Softstarter and PCEC Panel Solution by Sprecher+Schuh are designed to simplify installation, set-up, and typical operation of motors that drive hydraulic elevators and escalators. This solid state starter solution is designed to operate 3 phase standard squirrel cage induction motors and can be connected to a 6 or 12 lead Wye-Delta (Star-Delta) or standard 3 or 9 lead motors. Through the use of LINE or INSIDE-THE-DELTA control, the solid state solution can provide ultimate control of the motor. The advantages of a solid state solution include the following:

Provides smooth motor starting

- Decreases current surges on weak electrical systems
- Reduced starting torque of the motor helps to reduce mechanical stress on system components
- Helps meet both local and regional electrical codes when reduced voltage starting is a requirement
- Eliminates voltage and current spikes associated with traditional Wye-Delta (Star-Delta) starters
- Maximizes motor life due to reduced electrical strain
- Lowers general system maintenance requirements for improved uptime

The PCEC panel solution provides a standard PCE controller and a factory coordinated fault contactor on a common mounting plate for ease of installation. The PCE controller utilizes software optimized for the elevator industry along with a built-in selectable Class 10, 15 and 20 overload relay and SCR bypass to control all three phases. The pre-wired control harness (3 ft / ~1m flying leads) is supplied to simplify wiring into current installations while the mounting plate holes are the same as many standard Wye-Delta electro-mechanical starter panels. To insure start up performance both the PCE controller and PCEC panel assembly are factory tested before shipping.

The result is a quick and easy starter solution for the elevator and escalator industries.

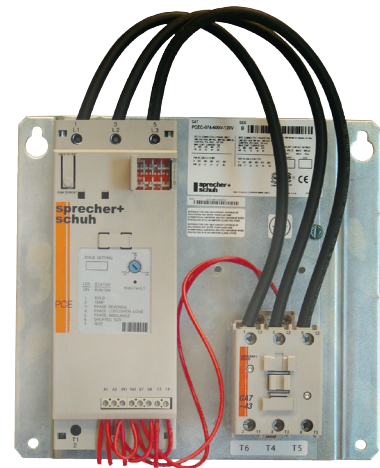

Microprocessor control provides precision operation

PCEC softstarters are under full microprocessor control, which limits starting current to the preset adjustable value. Current never exceeds the preset limit. Microprocessor control also provides finer increments of adjustment, facilitating smooth, repeatable, and accurate starting characteristics, independent of component aging and varying environmental conditions.

LED diagnostic display

An LED display indicates operating status and fault condition (overload, over temperature, phase reversal/phase loss, phase imbalance, shorted SCR, start fault). This enables speedy diagnosis and quick resolution of problems.

Standard fault contactor

The PCEC panel solution is equipped with a standard fault contactor which isolates one side of the motor windings from the line power in case of softstarter fault or motor overload. Current flow is prevented by this mechanical isolation in addition to the solid state SCRs.

UL/CSA Elevator Ratings

The PCEC Softstarters are UL Listed and cUL Listed (Canadian Standards per UL 508 and CS C22.2 No. 14-95) as solid state motor controllers in File E96956. They are also UL Listed and cUL Listed per UL 508 and CAN/CSA B44.1-96 as elevator controllers in File E3125.

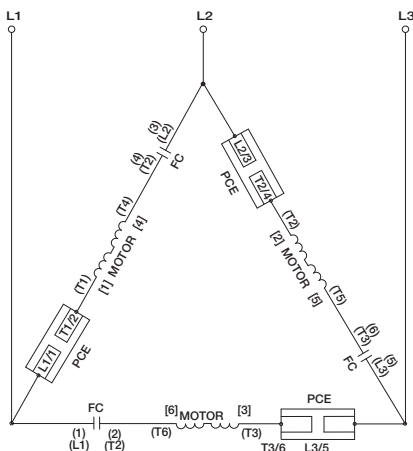

PCEC Hydraulic Elevator Softstarters are wired "inside the delta" for more efficient operation and retrofit

Current Limit Starting

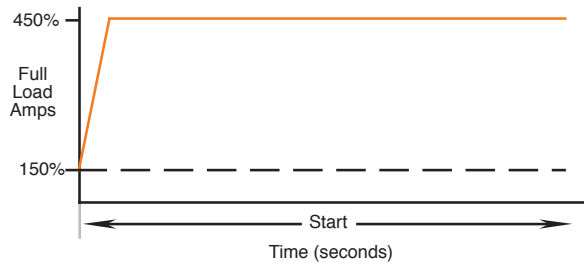

Through the use of internal current sensors, the PCEC will regulate the current level applied to the motor over the programmed period of time. This type of motor control produces a slow start and insures that the current does not exceed the programmed level. This is standard configuration of the device and aligns well with traditional applications.

Soft Start

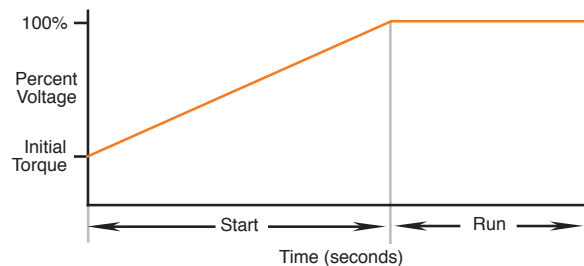

During Soft start, the voltage is ramped from an initial set point to full voltage over the programmed period of time. This type of motor control produces a smooth start in less time than the current limit setting, however the current is not restricted.

Soft Stop

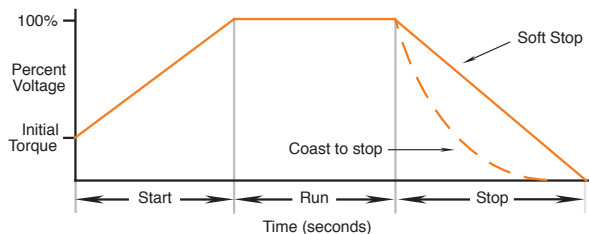

Soft stop provides the ability to ramp down the voltage applied to the motor over a programmed period of time. The result is a smooth stop.

Diagnostics

Overload	The built in motor overload provides protection of the motor for over current conditions. This protection feature offers a user selectable setting called the trip class, which can be used to accommodate different applications and motor types. When the motor draws more than the nominal value of current for a period of time, the device will fault on a motor overload fault.
Over Temperature	The product includes a built in self monitoring method for detecting a SCR over-temperature condition. If the internal temperature exceeds a design threshold the device will fault on a SCR Overtemp fault.
Phase Reversal	The user can select the phase relationship of the incoming power. If this phase relationship changes, the device will fault indicating a problem.
Phase Loss/Open Load	When any one of the incoming 3 phases are lost, the controller will fault indicating a phase loss condition has occurred.
Phase Imbalance	When enabled, this motor protection feature will detect if a phase imbalance condition exists and fault the unit. A phase imbalance is defined as a 65% differential between the highest and lowest phase for more than 3 seconds.
Shorted SCR	Each time the PCEC initiates a start, it checks to see if the SCR's are operating correctly. If the controller is unable to properly turn on and off any one of the SCR's, the device will fault on a Shorted SCR fault.

D
PCEC Hydraulic Elevator Softstarters

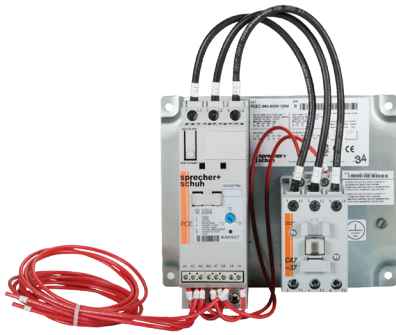

Frame Size 1 - 32...64 Amp



Frame Size 2 - 74...147 Amp



Frame Size 3 - 234 Amp

PCEC Controller Panel - 120V Control Voltage ④⑥

DELTA Connected - 6 Wire ②					Line Connected - 3 Wire ②					Frame Size	With 120VAC 50/60 Hz ②③ Control Voltage Catalog Number
Maximum Horsepower				Overload Range ①	Maximum Horsepower				Overload Range ①		
200V	240V	480V	575V		200V	240V	480V	575V			
10	10	20	30	10.9...32.9	5	5	10	15	6.3...19	1	PCEC-032-600V-120V
15	15	30	40	17...51	7.5	10	20	25	10...30	1	PCEC-051-600V-120V
20	20	40	60	21.3...64	10	10	25	30	12.3...37	1	PCEC-064-600V-120V
20	25	50	60	24.7...74	10	15	30	40	14.3...43	2	PCEC-074-600V-120V
30	40	75	100	34.7...104	15	20	40	50	20...60	2	PCEC-104-600V-120V
40	50	100	150	49...147	25	30	60	75	28.3...85	2	PCEC-147-600V-120V
75	75	150	200	59...234	40	50	100	125	34...135	3	PCEC-234-600V-120V ⑤

PCEC Controller Panel - 230V Control Voltage ④⑥

DELTA Connected - 6 Wire ②					Line Connected - 3 Wire ②					Frame Size	With 230VAC 50/60 Hz ②③ Control Voltage Catalog Number
Maximum Horsepower				Overload Range ①	Maximum Horsepower				Overload Range ①		
200V	240V	480V	575V		200V	240V	480V	575V			
10	10	20	30	10.9...32.9	5	5	10	15	6.3...19	1	PCEC-032-600V-230V
15	15	30	40	17...51	7.5	10	20	25	10...30	1	PCEC-051-600V-230V
20	20	40	60	21.3...64	10	10	25	30	12.3...37	1	PCEC-064-600V-230V
20	25	50	60	24.7...74	10	15	30	40	14.3...43	2	PCEC-074-600V-230V
30	40	75	100	34.7...104	15	20	40	50	20...60	2	PCEC-104-600V-230V
40	50	100	150	49...147	25	30	60	75	28.3...85	2	PCEC-147-600V-230V
75	75	150	200	59...234	40	50	100	125	34...135	3	PCEC-234-600V-230V ⑤

- ① Motor FLA must fall within the specified range to operate correctly.
- ② The PCEC Controller panel powerwire jumpers and parameter DIP switch settings are shipped in the DELTA connection mode by default. LINE connection requires the power wires to be reconfigured and DIP Switch #15 to be programmed for LINE connection mode by the customer.
- ③ Internal fan is optional for PCEC-032...064. See page D19 to purchase separately. All other PCEC units have internal fan as standard.
- ④ Purchase additional PCE Auxiliary Contact Blocks separately. See page D30. One Auxiliary Contact Block (one or two pole) may be mounted on the right side of the PCE controller.

- ⑤ Separate 120V or 240V single phase is required for PCEC fan operation.
- ⑥ The PCEC Hydraulic Elevator duty rating is 80 starts per hour at 50% duty cycle (160 calls per hour). Starts per hour are based on when the motor starts, the motor only runs on "up" calls. Installing an optional fan (PCV-64) is recommended for PCEC-032A...064A for maximum starts per hour performance. All other PCEC units have an internal fan as standard.

PCEC Controller Panel
(Complete Assembly)

PCE Controller Only

Fault Contactor (FC)

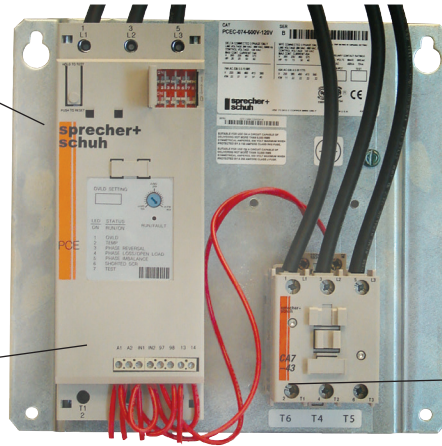



PCEC-074-600V-120V

Replacement Parts

Complete Assembly (For Reference Only)	PCE Controller Only	PCE Fans	Fault Contactor	Fault Contactor Coil	
PCEC-032-600V-120V	PCE-032-600V	PCV-064 (optional)	CA7-37-00-120	TC473	
PCEC-051-600V-120V	PCE-051-600V		CA7-37-00-120		
PCEC-064-600V-120V	PCE-064-600V		CA7-37-00-120		
PCEC-074-600V-120V	PCE-074-600V	PCV-147	CA7-43-00-120	TD473	
PCEC-104-600V-120V	PCE-104-600V		CA7-60-00-120	TE473	
PCEC-147-600V-120V	PCE-147-600V		CA7-85-00-120	TE473	
PCEC-234-600V-120V	Complete Device	PCV-234	CA6-180-EI-11-120	CA6-TGE865	
	Control Module				PCE-234
	Power Pole				PFL-0135-600V ①
	Terminal Cover				PFT-0135
PCEC-032-600V-230V	PCE-032-600V	PCV-064 (optional)	CA7-37-00-220W	TC296	
PCEC-051-600V-230V	PCE-051-600V		CA7-37-00-220W		
PCEC-064-600V-230V	PCE-064-600V		CA7-37-00-220W		
PCEC-074-600V-230V	PCE-074-600V	PCV-147	CA7-43-00-220W	TD296	
PCEC-104-600V-230V	PCE-104-600V		CA7-60-00-220W	TE296	
PCEC-147-600V-230V	PCE-147-600V		CA7-85-00-220W	TE296	
PCEC-234-600V-230V	Complete Device	PCV-234	CA6-180-EI-11-220W	CA6-TGE866	
	Control Module				PCE-234
	Power Pole				PFL-0135-600V ①
	Terminal Cover				PFT-0135

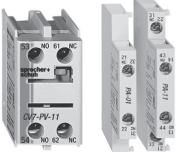
Optional Accessories

	See page D30 for PCE Controller Auxiliaries		See page A47 for Fault Contactor Front and Side Mount Auxiliaries		See page D19 for Protection Modules		See page D19 for Internal Fan
---	---	---	--	---	--	---	----------------------------------

① Part number contains three power poles.

Electrical

Power Circuit	UL/cUL/CSA	IEC
Rated Operational Voltage	200...600V AC	200...500V~
Rated Insulation Voltage	600V AC	500V~
Dielectric Withstand	2200V AC	2500V~
Repetitive Peak	200...600V AC: 1600	500V~: 1600
Rated Impulse Voltage	6 kV	
Over-voltage Category	III	
Number of Poles	Equipment designed for 3 phase only	
Operating Frequency	50/60 Hz	
Controller Utilization Category	32/51/64	AC-53b: 3.5-15:3585
	74/104/147	AC-53b: 4.5-30:1770
	234	AC-53b: 3.5-30:1770
Overload Current Range (Amps)	LINE	DELTA
32	6.3...19	10.9...32.8
51	10...30	17...51
64	12.3...37	21.3...64
74	14.3...43	24.7...74
104	20...60	34.7...104
147	28.3...85	49 ...147
234	34...135	59...234
Control Circuit	UL/cUL/CSA	IEC
Rated Operational Voltage	100...120 V AC, 200...240V AC	120~, 240~
Rated Insulation Voltage	NA	300V~
Dielectric Withstand	NA	3000V
Rated Impulse Voltage	3kV	
Operating Frequency	50/60 Hz	
Control Power Requirements	32/51/64	215 mA @ 120 V AC , 180 mA @ 240 V AC
	74/104/147	200 mA @ 120 V AC , 100 mA @ 240 V AC
	234	200 mA @ 120 V AC , 120 mA @ 240 V AC
Fan Power Requirements	32/51/64	NA
	74/104/147	NA
	234	20 VA

Electrical (continued)

Short Circuit Performance		Type 1
Device Current Rating	Max Fuse Size and Type	Max Available Fault Rating
32	70 A - RK5	5 kA
	125 A - K5	5 kA
51	125 A - RK5	5 kA
	200 A - K5	10 kA
64	125 A - RK5	5 kA
	200 A - K5	10 kA
74	150 A - RK5	5 kA
	250 A - J	10 kA
104	200 A - RK5	5 kA
	400 A - J	10 kA
147	250 A - RK5	10 kA
	400 A - J	10 kA
234	400 A - RK5	10 kA
	450 A - K5	10 kA

Auxiliary Contacts (Fault and Aux#1)	UL/cUL/CSA	IEC
Rated Operational Voltage	250V AC / 30V DC	250V~ / 30V DC
Rated Insulation Voltage	250V	250V~
Rated Impulse Voltage	NA	4kV
Dielectric Withstand	1500V AC	2000V~
Operating Frequency	50/60 Hz	
Utilization Category	D300	AC-15 / DC
Type of Control Circuit	Electromagnetic Relay	
Number of Contacts	1	
Type of contacts	Normally Open (N.O.)	
Type of current	AC/DC	
Rated Operational Current (Max.)	0.6 A @ 120 V~ and 0.3 A @ 240V~	
Conventional Thermal Current (Ith)	1 Amp	
Make/Break VA	432/72	

Mechanical

Resistance to Vibration	Operational	1.0 G Peak, 0.15 mm (0.006 in) displacement
	Non-operational	2.5 G Peak, 0.38 mm (0.015 in) displacement
Resistance to Shock	Operational	15 G
	Non-operational	5.5 G

Environmental

Operating Temperature	0...50°C (32...122°F) Open
	0...40°C (32...104°F) Enclosed
Altitude	2000 m (6560 ft)
Humidity	5...95% (non-condensing)
Pollution Degree	2

UL/CSA Elevator Ratings

The PCEC Softstarters are UL Listed and cUL Listed (Canadian Standards per UL 508 and CS C22.2 No. 14-95) as solid state motor controllers in File E96956. They are also UL Listed and cUL Listed per UL 508 and CAN/CSA B44.1-96 as elevator controllers in File E3125.

D
PCEC Hydraulic Elevator Softstarters

Motor FLA Adjustments

The front of the PCE controller contains a dial which is used for setting the actual FLA of the motor. The label is designed to accommodate motors connected in the LINE or DELTA mode. To determine the proper setting, look at the motors nameplate and set the dial accordingly. The dial setting can be modified depending on the service factor of the motor as shown:

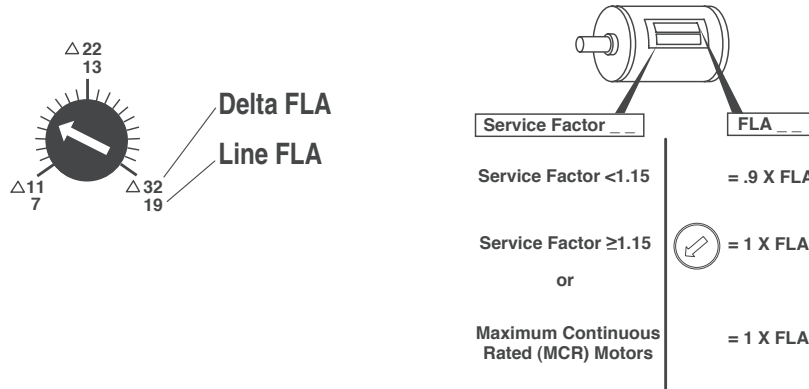

Motor Overload Trip Curves

The trip class should be set according to the motors maximum permissible locked rotor time or the general thermal capabilities. Consult the motor manufacturer for recommendations on setting the trip class.

--- Hot — Cold

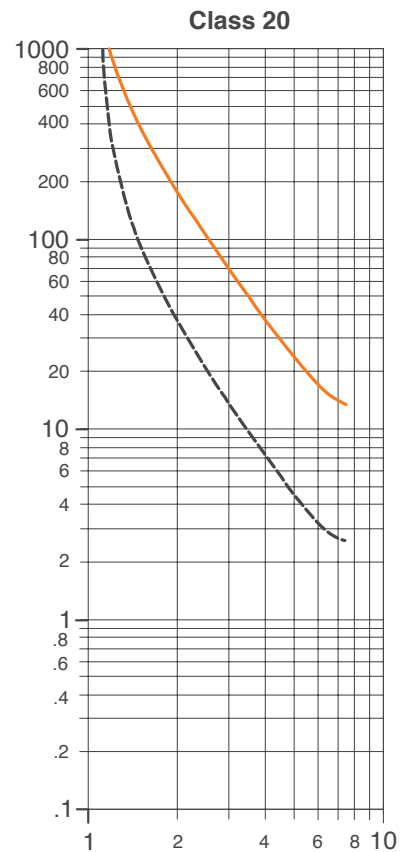
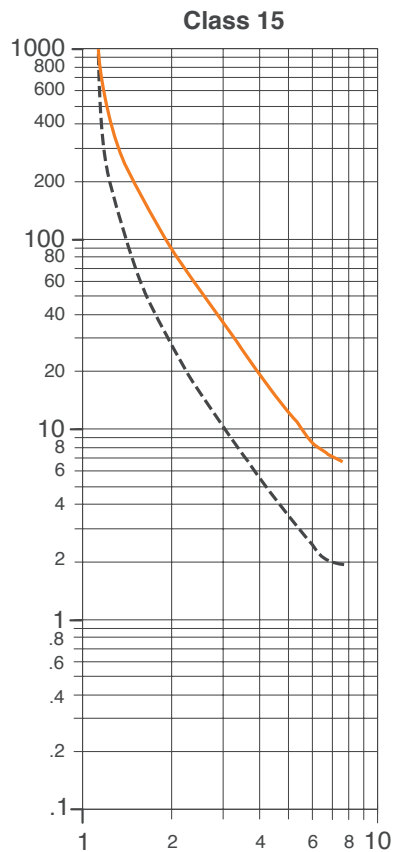
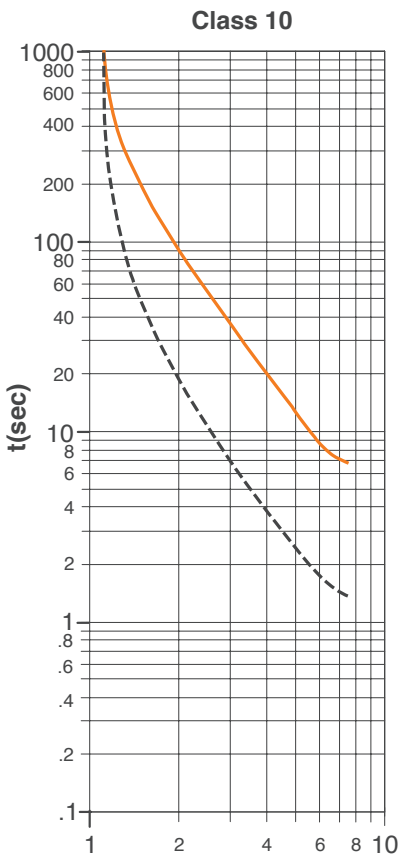

Terminal Torque Specifications
PCE Controller Information

Controller Size	Units	Line Power Terminals	Load Power Terminals	Control Power Terminals
32/51/64	Wire Size	14 - 4 AWG (2.5 - 25 mm ²)	14 - 6 AWG (2.5 - 16 mm ²)	24 - 14 AWG (0.2 - 2.5 mm ²)
	Torque	20 - 25 lb-in. (2.3 - 2.8 Nm)	20 - 22.5 lb-in. (2.3 - 2.6 Nm)	4.4 - 8 lb-in. (0.5 - 0.9 Nm)
74/104/147	Wire Size	14 - 3/0 AWG (2.5 - 95 mm ²)	14 - 1 AWG (2.5 - 50 mm ²)	24 - 14 AWG (0.2 - 2.5 mm ²)
	Torque	100 - 110 lb-in. (11.3 - 12.4 Nm)	100 - 110 lb-in. (11.3 - 12.4 Nm)	4.4 - 8 lb-in. (0.5 - 0.9 Nm)
234	Wire Size	6 - 250 AWG (16 - 120 mm ²)	6 - 250 AWG (16 - 120 mm ²)	24 - 14 AWG (0.2 - 2.5 mm ²)
	Torque	275 lb-in. (31 Nm)	275 lb-in. (31 Nm)	4.4 - 8 lb-in. (0.5 - 0.9 Nm)

Fault Contactor Information

Controller Size	Units	Line Power Terminals	Load Power Terminals	Control Power Terminals
32/51/64/74	Wire Size	14 - 4 AWG (2.5 - 16 mm ²)	14 - 4 AWG (2.5 - 16 mm ²)	16 - 12 AWG (1.5 - 6 mm ²)
	Torque	22 - 35 lb. in. (2.5 - 4 Nm)	22 - 35 lb. in. (2.5 - 4 Nm)	9 - 13 lb. in. (1 - 2.5 Nm)
104/147	Wire Size	14 - 1 AWG (2.5 - 35 mm ²)	14 - 1 AWG (2.5 - 35 mm ²)	16 - 12 AWG (1.5 - 6 mm ²)
	Torque	31 - 53 lb. in. (3.5 - 6 Nm)	31 - 53 lb. in. (3.5 - 6 Nm)	9 - 13 lb. in. (1 - 2.5 Nm)
234	Wire Size	6 - 300 AWG (16 - 150 mm ²)	6 - 300 AWG (16 - 150 mm ²)	2x 16...12 AWG (2x 1...4 mm ²)
	Torque	250 lb-in. (28 Nm)	250 lb-in. (28 Nm)	12 - 20 lb-in. (1.4 - 2.3 Nm)

DELTA Connection Diagrams, Power, and Motor Wiring

- 1- CONTROL POWER (L)
- 2- CONTROL COMMON (N)
- 4- START ENABLE
- 13- UP TO SPEED INDICATION

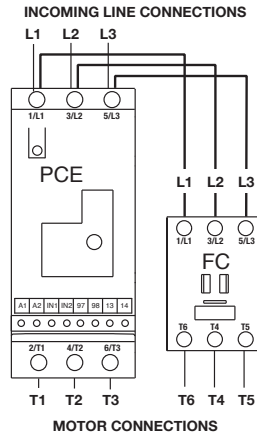
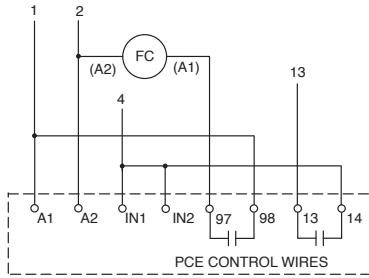

PCEC 32...147A

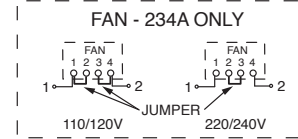
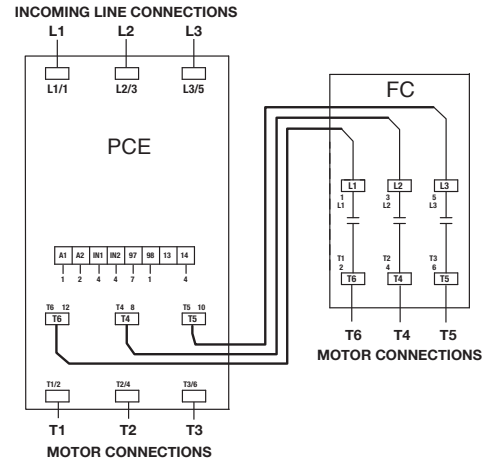

PCEC 234A

PCEC Hydraulic Elevator Softstarters

DELTA Connection Diagrams, Power, and Motor Wiring

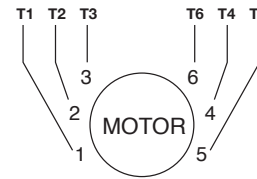
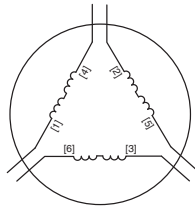
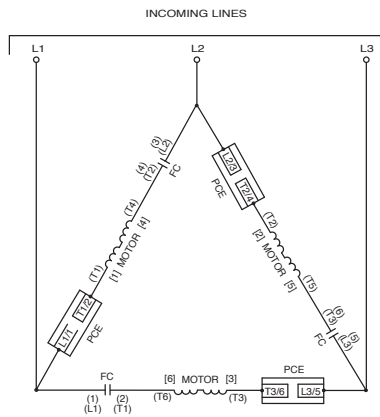

6 LEAD MOTOR CONNECTIONS							
STARTER TERMINALS	T1	T2	T3	T6	T4	T5	JUMPER
MOTOR TERMINALS	1	2	3	6	4	5	N/A

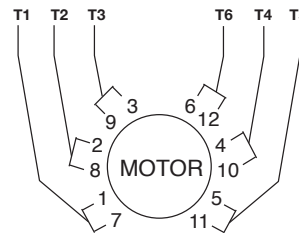
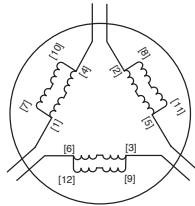
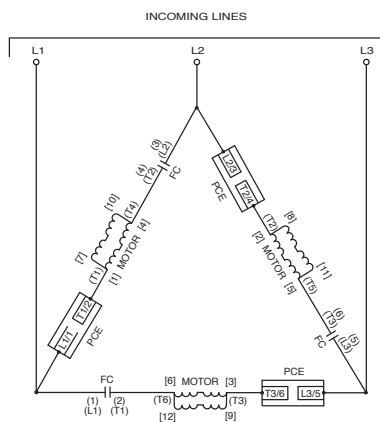

12 LEAD 230V LOW VOLTAGE MOTOR CONNECTIONS							
STARTER TERMINALS	T1	T2	T3	T6	T4	T5	JUMPER
MOTOR TERMINALS	1&7	2&8	3&9	6&12	4&10	5&11	N/A

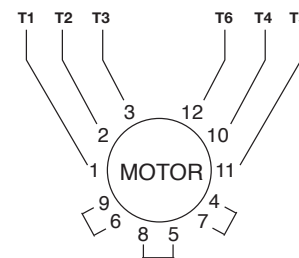
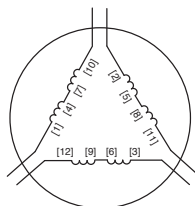
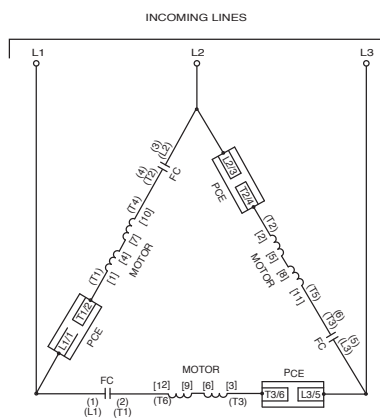

12 LEAD 460V HIGH VOLTAGE MOTOR CONNECTIONS							
STARTER TERMINALS	T1	T2	T3	T6	T4	T5	JUMPER
MOTOR TERMINALS	1	2	3	12	10	11	4&7 5&8 6&9

D PCEC Hydraulic Elevator Softstarters

LINE Connection Diagrams, Power, and Motor Wiring

- 1- CONTROL POWER (L)
- 2- CONTROL COMMON (N)
- 4- START ENABLE
- 13- UP TO SPEED INDICATION

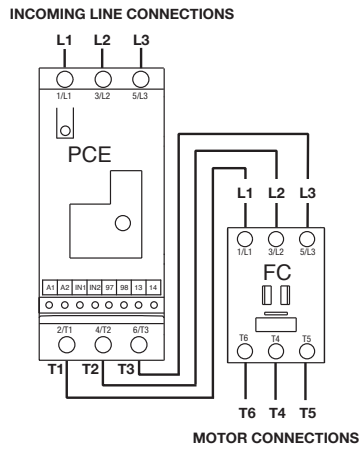
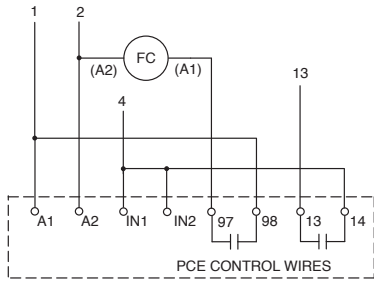

PCEC 32...147A

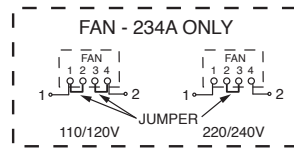
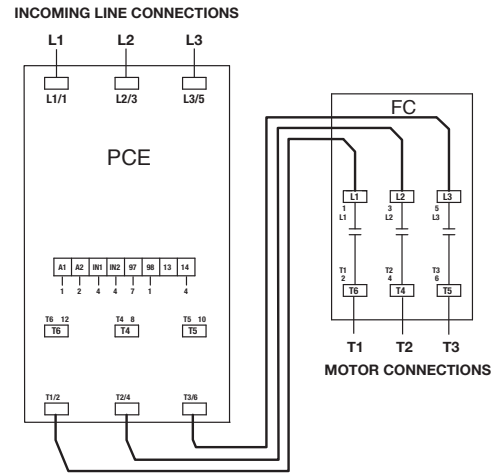

PCEC 234A

Note: The power wire configuration and DIP switch settings must be changed for the Line Connection method.

PCEC Hydraulic Elevator Softstarters

D

LINE Connection Diagrams, Power, and Motor Wiring

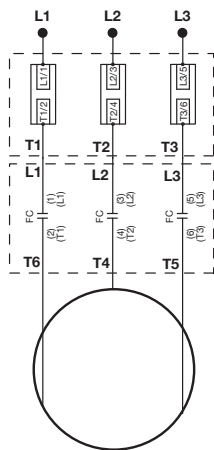

WYE

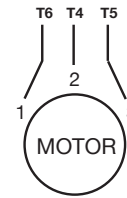
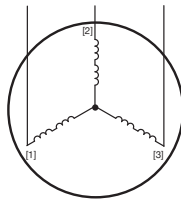

DELTA

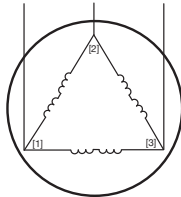

3 LEAD MOTOR CONNECTIONS				
STARTER TERMINALS	T6	T4	T5	JUMPER
WYE & DELTA MOTOR TERMINALS	1	2	3	N/A

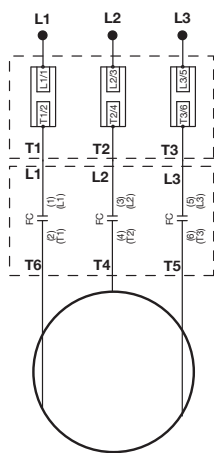

WYE

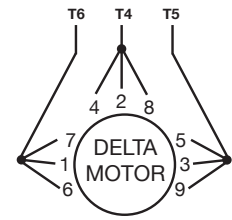
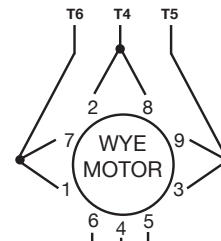
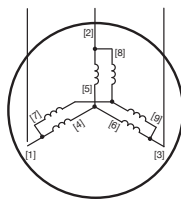

DELTA

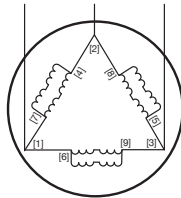

9 LEAD, 230V LOW VOLTAGE, MOTOR CONNECTIONS				
STARTER TERMINALS	T6	T4	T5	JUMPER
WYE MOTOR TERMINALS	1 & 7	2 & 8	3 & 9	4, 5, 6
DELTA MOTOR TERMINALS	1,6,7	2,4,8	3,5,9	N/A

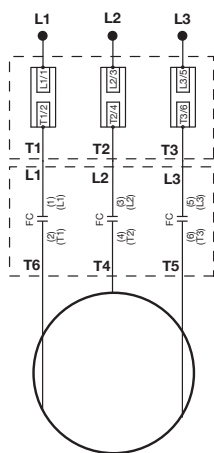

WYE

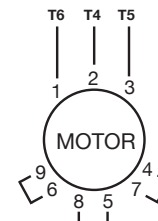
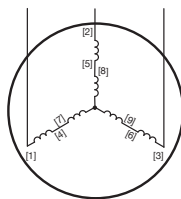

DELTA

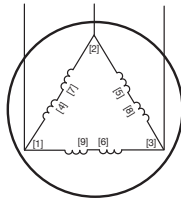

9 LEAD, 460V HIGH VOLTAGE, MOTOR CONNECTIONS				
STARTER TERMINALS	T6	T4	T5	JUMPER
WYE & DELTA MOTOR TERMINALS	1	2	3	4 & 7 5 & 8 6 & 9

D PCEC Hydraulic Elevator Softstarters

DELTA Connected Controller - Typical Control Wiring

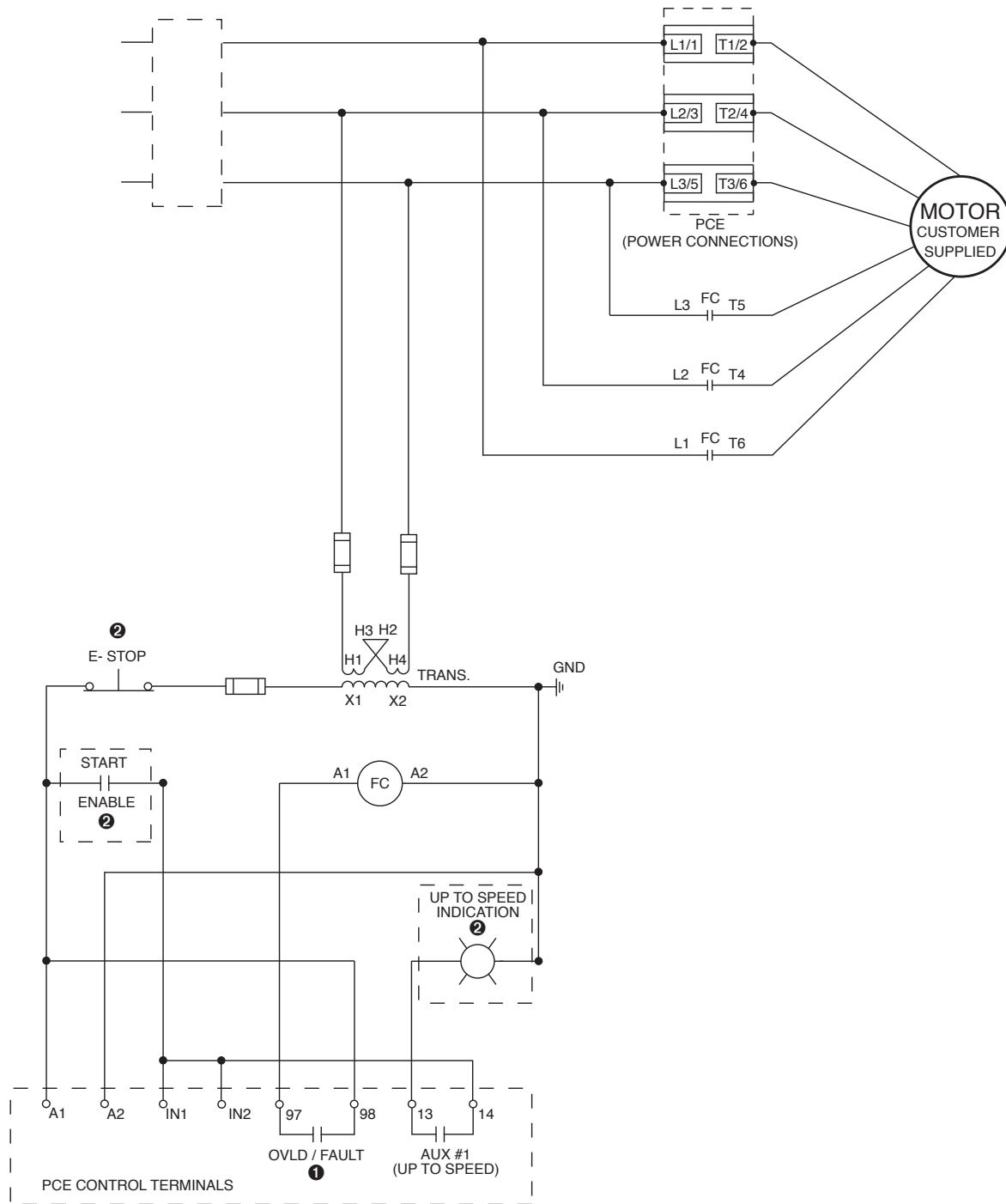

❶ When (A1)(A2) control power is applied, (97)(98) contact closes instantaneously and opens when the PCE detects an overload or fault condition, or when control power is removed.

❷ Customer supplied.

LINE Connected Controller - Typical Control Wiring

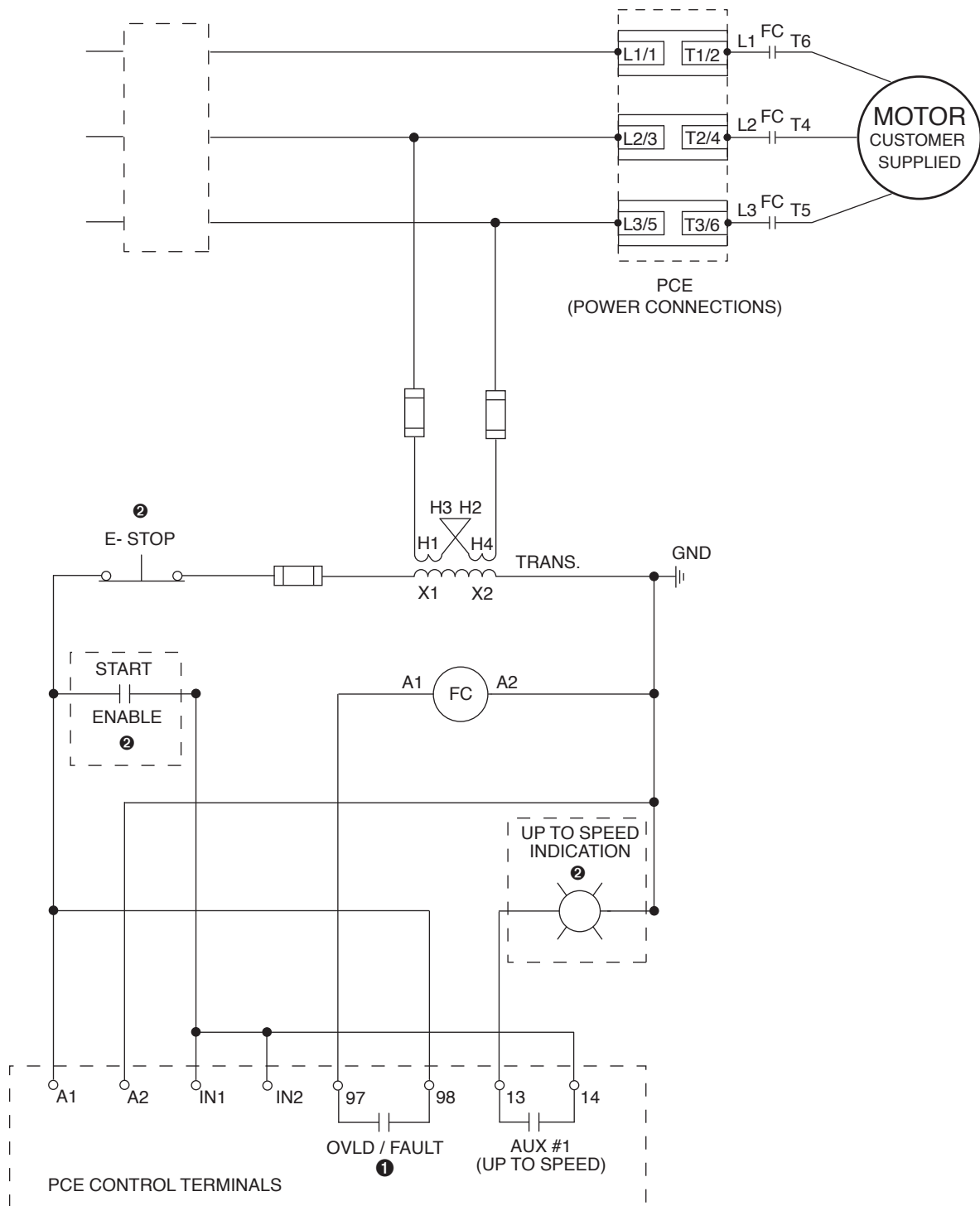

❶ When (A1)(A2) control power is applied, (97)(98) contact closes instantaneously and opens when the PCE detects an overload or fault condition, or when control power is removed.

❷ Customer supplied.

D
PCEC Hydraulic Elevator Softstarters

PCEC Hydraulic Elevator Softstarter

Dimensions are in millimeters (inches). Dimensions not intended for manufacturing purposes.

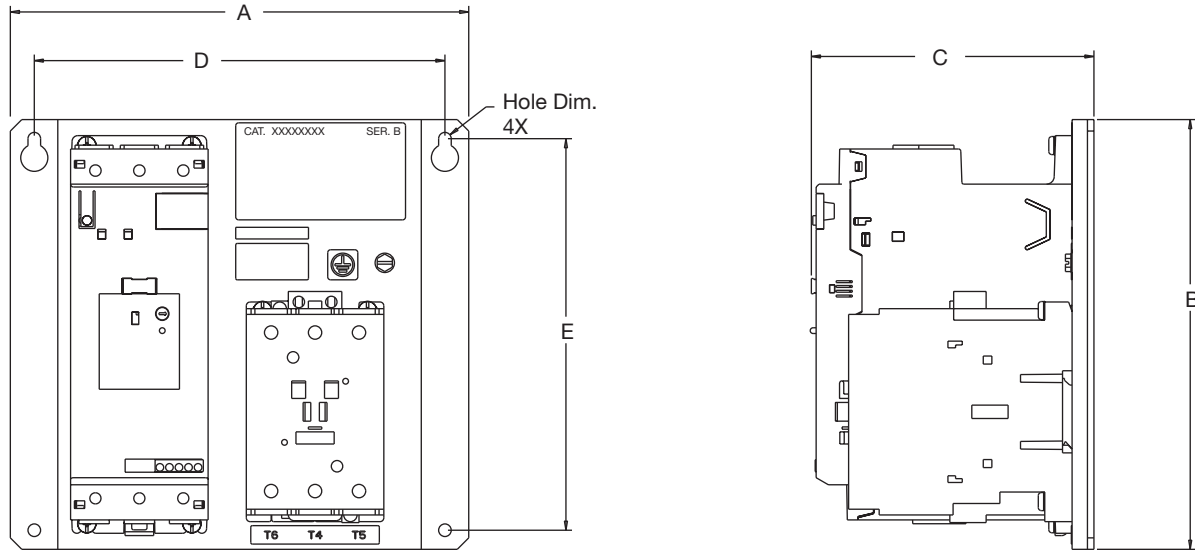

Controller Size	Units	A (Width)	B (Height)	C (Depth)	D	E	Hole Dim - 4x	Approx. Weight
32/51/64	mm	178	144	115.7	165.1	127.0	5.6	4 lbs (2 kg)
	in	7.01	5.67	4.56	6.50	5.00	0.22	
74/104/147	mm	240	225	147.9	215	205	6.6	14 lbs (6 kg)
	in	9.45	8.86	5.82	8.46	8.07	0.260	
234	mm	362	515	216.4	330.2	489.5	8.7	51 lbs (23 kg)
	in	14.25	20.28	8.52	13.00	19.27	0.343	

D PCEC Hydraulic Elevator Softstarters