

Series L8 UL1077 Supplementary Protectors

Supplemental short circuit protection for a variety of applications up to 63 Amps

Sprecher+Schuh Series L8 Supplementary Protectors provide supplemental overcurrent protection for control circuits, solenoids, actuators, appliances, business equipment and a range of other applications where a high performance current limiting device is required. Advanced features and global approvals make them ideal for use in equipment installed throughout the world.

Broad product range

Series L8 Supplementary Protectors are available in up to 20 different current ratings from 0.5A to 63A, in one, two and three pole configurations. Over 180 base models are available with a full compliment of accessories.

Devices can be used in applications up to 480V AC and 48V DC with interrupting capacities up to 10kA.

Safety features provide enhanced protection

The terminals of Series L8 Supplementary Protectors provide IP20 protection to guard against accidental contact with live parts.

To aid troubleshooting, a color-coded indicator provides positive visual indication of the device status (green for OFF, red for ON) and isolation function.

Sprecher+Schuh Supplementary Protectors also incorporate a trip-free mechanism - ensuring that the device operation cannot be defeated by holding the operator in the ON position.

Easy installation

Sprecher+Schuh Supplementary Protectors mount on a standard 35mm DIN-rail. Wire terminals accept multiple conductors, and UL 508 approved bus bars can be used to quickly distribute power to many Supplementary Protectors simultaneously. In addition, power to the circuit breakers can be fed from the line or load side.

Global approvals for worldwide acceptance

Series L8 Supplementary Protectors are UL Recognized for use in the United States in accordance with NFPA 79 (NEC, National Electrical Code). The devices comply with UL 1077 and CSA 22.2 No.235, meeting the requirements for supplementary protectors intended for use as overcurrent protection where branch circuit protection is not required, or is provided by another device such as a fuse or molded case circuit breaker. These Supplementary Protectors also comply with IEC 60947-2 for use in commercial and residential applications and are CE marked.

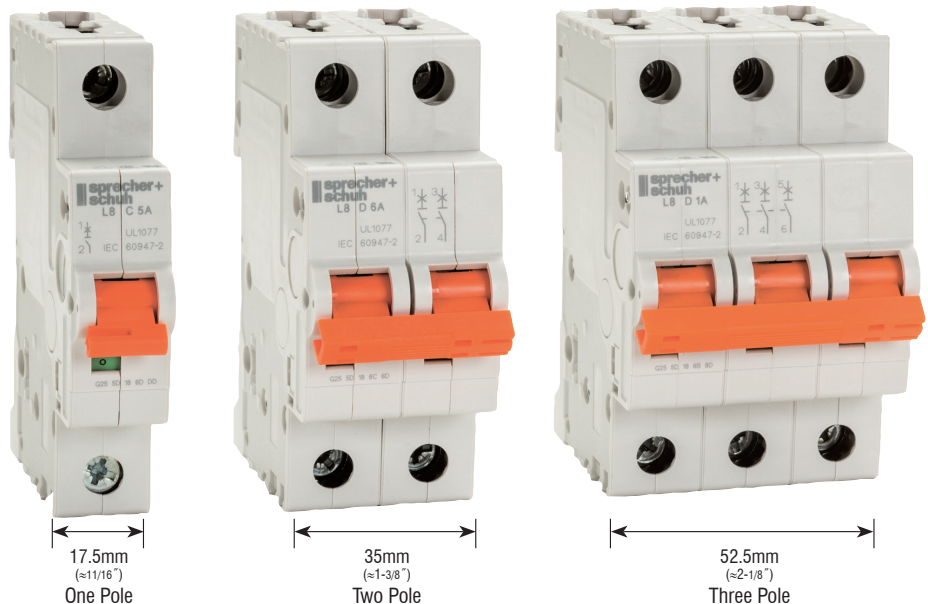

See online white paper

Methods

of Applying

Circuit Protection

Three trip characteristics

All Sprecher+Schuh L8 Supplementary Protectors are available with three different tripping characteristics, Type “B”, “C”, and “D”. The tripping characteristic defines the device’s speed of response (trip-time) to various levels of overcurrent. Figure 1 shows trip-time versus overcurrent for Type B, C, and D devices. The time-current characteristics enable the device to be optimally matched to the application. For example, PLC outputs that can only tolerate minimal overcurrents are best protected by Supplementary Protectors with Type B trip characteristics.

Sprecher+Schuh L8 Supplementary Protectors are also current limiting - interrupting fault currents within one half cycle. Current limiting devices protect circuit components from damage by reducing the peak let-through current which causes damaging magnetic forces

and let-through energy which generates heat.

Type “B” Characteristic

Developed primarily to protect conductors and low level signal devices such as PLCs. Instantaneous trip is three to five times the rated current of the Supplementary Protector ($3\sim 5 \times I_n$). The fast trip time of these devices minimizes damage to control circuit conductors from low-level faults.

Type “C” Characteristic

Developed primarily for applications with moderate inrush currents such as lighting, control circuits and coils, computers and appliances. Instantaneous trip is five to ten times the rated current of the Supplementary Protector ($5\sim 10 \times I_n$). The higher instantaneous trip level prevents nuisance tripping, and components being protected can typically withstand higher fault currents without being damaged.



Type “D” Characteristic

Developed primarily for applications with high inrush currents, i.e., transformers, power supplies and heaters. Instantaneous trip is ten to twenty times the rated current of the Supplementary Protector ($10\sim 20 \times I_n$). The high instantaneous trip level prevents nuisance tripping, and components being protected can typically withstand higher fault currents without being damaged.

Compare these advanced features

Box lug terminals accept #18...#4 (1.0...25mm²) wire as standard

Ratings to 480Y/277V AC @ 230/440V AC - 10kA Interrupt Rating

Amp rating and trip curve characteristic clearly marked on the device for easy identification

Magnetic trip elements provide Type B, C and D trip characteristics, while bimetallic elements protect against slight overloads.

Line and load side terminals designed with dual terminals which allows the connection of two wires, or both a wire and a bus bar.

Guarded No.2 pozidrive terminal screws with finger-safe IP20 protection

Devices install on standard 35mm DIN-rail (EN 50022)

Trip-free mechanism; device operation cannot be defeated by holding the operator in the ON position

Color coded indicator provides visual indication of the device status and isolation function

Available in one, two and three pole



L8 Supplementary Protectors

Trip Characteristic B (3~5 x I_N) – Resistive or slightly inductive loads ③

Rated Current (A)	1 Pole ①		2 Pole ②		3 Pole ②	
	Catalog Number	Std. Pkg.	Catalog Number	Std. Pkg.	Catalog Number	Std. Pkg.
0.5	L8-0.5/1/B	2	L8-0.5/2/B	1	L8-0.5/3/B	1
1	L8-1/1/B	2	L8-1/2/B	1	L8-1/3/B	1
2	L8-2/1/B	2	L8-2/2/B	1	L8-2/3/B	1
3	L8-3/1/B	2	L8-3/2/B	1	L8-3/3/B	1
4	L8-4/1/B	2	L8-4/2/B	1	L8-4/3/B	1
5	L8-5/1/B	2	L8-5/2/B	1	L8-5/3/B	1
6	L8-6/1/B	2	L8-6/2/B	1	L8-6/3/B	1
7	L8-7/1/B	2	L8-7/2/B	1	L8-7/3/B	1
8	L8-8/1/B	2	L8-8/2/B	1	L8-8/3/B	1
10	L8-10/1/B	2	L8-10/2/B	1	L8-10/3/B	1
13	L8-13/1/B	2	L8-13/2/B	1	L8-13/3/B	1
15	L8-15/1/B	2	L8-15/2/B	1	L8-15/3/B	1
16	L8-16/1/B	2	L8-16/2/B	1	L8-16/3/B	1
20	L8-20/1/B	2	L8-20/2/B	1	L8-20/3/B	1
25	L8-25/1/B	2	L8-25/2/B	1	L8-25/3/B	1
30	L8-30/1/B	2	L8-30/2/B	1	L8-30/3/B	1
32	L8-32/1/B	2	L8-32/2/B	1	L8-32/3/B	1
40	L8-40/1/B	2	L8-40/2/B	1	L8-40/3/B	1
50	L8-50/1/B	2	L8-50/2/B	1	L8-50/3/B	1
63	L8-63/1/B	2	L8-63/2/B	1	L8-63/3/B	1

L8 Supplementary Protector Features:

- UL-1077 Approved, CSA 22.2 No. 235 and IEC/EN 60947-2
- Thermal Magnetic Overcurrent Protection
- Trip characteristics based on 40°C ambient for UL/CSA
- Up to 10kA interruption ratings
- Finger safe design
- DIN-rail mounting

① 1-Pole ratings: UL/CSA 277VAC 48VDC, IEC 240/440VAC

② Multi-pole ratings: UL/CSA 480Y/277VAC 96VDC, IEC 440VAC

③ See UL Short Circuit ratings U1/U2 in the technical data sections.

Trip Characteristic C (5~10 x I_N) – Inductive loads ③

Rated Current (A)	1 Pole ①		2 Pole ②		3 Pole ②	
	Catalog Number	Std. Pkg.	Catalog Number	Std. Pkg.	Catalog Number	Std. Pkg.
0.5	L8-0.5/1/C	2	L8-0.5/2/C	1	L8-0.5/3/C	1
1	L8-1/1/C	2	L8-1/2/C	1	L8-1/3/C	1
2	L8-2/1/C	2	L8-2/2/C	1	L8-2/3/C	1
3	L8-3/1/C	2	L8-3/2/C	1	L8-3/3/C	1
4	L8-4/1/C	2	L8-4/2/C	1	L8-4/3/C	1
5	L8-5/1/C	2	L8-5/2/C	1	L8-5/3/C	1
6	L8-6/1/C	2	L8-6/2/C	1	L8-6/3/C	1
7	L8-7/1/C	2	L8-7/2/C	1	L8-7/3/C	1
8	L8-8/1/C	2	L8-8/2/C	1	L8-8/3/C	1
10	L8-10/1/C	2	L8-10/2/C	1	L8-10/3/C	1
13	L8-13/1/C	2	L8-13/2/C	1	L8-13/3/C	1
15	L8-15/1/C	2	L8-15/2/C	1	L8-15/3/C	1
16	L8-16/1/C	2	L8-16/2/C	1	L8-16/3/C	1
20	L8-20/1/C	2	L8-20/2/C	1	L8-20/3/C	1
25	L8-25/1/C	2	L8-25/2/C	1	L8-25/3/C	1
30	L8-30/1/C	2	L8-30/2/C	1	L8-30/3/C	1
32	L8-32/1/C	2	L8-32/2/C	1	L8-32/3/C	1
40	L8-40/1/C	2	L8-40/2/C	1	L8-40/3/C	1
50	L8-50/1/C	2	L8-50/2/C	1	L8-50/3/C	1
63	L8-63/1/C	2	L8-63/2/C	1	L8-63/3/C	1

L8 Supplementary Protector Features:

- UL-1077 Approved, CSA 22.2 No. 235 and IEC/EN 60947-2
- Thermal Magnetic Overcurrent Protection
- Trip characteristics based on 40°C ambient for UL/CSA
- Up to 10kA interruption ratings
- Finger safe design
- DIN-rail mounting

① 1-Pole ratings: UL/CSA 277VAC 48VDC, IEC 240/440VAC
 ② Multi-pole ratings: UL/CSA 480Y/277VAC 96VDC, IEC 440VAC
 ③ See UL Short Circuit ratings U1/U2 in the technical data sections.

Trip Characteristic D (10~20 x I_N) – Highly inductive loads ③

Rated Current (A)	1 Pole ①		2 Pole ②		3 Pole ②	
	Catalog Number	Std. Pkg.	Catalog Number	Std. Pkg.	Catalog Number	Std. Pkg.
0.5	L8-0.5/1/D	2	L8-0.5/2/D	1	L8-0.5/3/D	1
1	L8-1/1/D	2	L8-1/2/D	1	L8-1/3/D	1
2	L8-2/1/D	2	L8-2/2/D	1	L8-2/3/D	1
3	L8-3/1/D	2	L8-3/2/D	1	L8-3/3/D	1
4	L8-4/1/D	2	L8-4/2/D	1	L8-4/3/D	1
5	L8-5/1/D	2	L8-5/2/D	1	L8-5/3/D	1
6	L8-6/1/D	2	L8-6/2/D	1	L8-6/3/D	1
7	L8-7/1/D	2	L8-7/2/D	1	L8-7/3/D	1
8	L8-8/1/D	2	L8-8/2/D	1	L8-8/3/D	1
10	L8-10/1/D	2	L8-10/2/D	1	L8-10/3/D	1
13	L8-13/1/D	2	L8-13/2/D	1	L8-13/3/D	1
15	L8-15/1/D	2	L8-15/2/D	1	L8-15/3/D	1
16	L8-16/1/D	2	L8-16/2/D	1	L8-16/3/D	1
20	L8-20/1/D	2	L8-20/2/D	1	L8-20/3/D	1
25	L8-25/1/D	2	L8-25/2/D	1	L8-25/3/D	1
30	L8-30/1/D	2	L8-30/2/D	1	L8-30/3/D	1
32	L8-32/1/D	2	L8-32/2/D	1	L8-32/3/D	1
40	L8-40/1/D	2	L8-40/2/D	1	L8-40/3/D	1
50	L8-50/1/D	2	L8-50/2/D	1	L8-50/3/D	1
63	L8-63/1/D	2	L8-63/2/D	1	L8-63/3/D	1

L8 Supplementary Protector Features:





- UL-1077 Approved, CSA 22.2 No. 235 and IEC/EN 60947-2
- Thermal Magnetic Overcurrent Protection
- Trip characteristics based on 40°C ambient for UL/CSA
- Up to 10kA interruption ratings
- Finger safe design
- DIN-rail mounting

① 1-Pole ratings: UL/CSA 277VAC 48VDC, IEC 240/440VAC

② Multi-pole ratings: UL/CSA 480Y/277VAC 96VDC, IEC 440VAC

③ See UL Short Circuit ratings U1/U2 in the technical data sections.

Accessories

Module	Description	For use with...	UL/CSA Max. Current/Voltage	IEC Ratings Current/Voltage	Connection Diagrams	Catalog Number
	Auxiliary/Signal Contact • Mounts on right side of L8 (series B only) ❶	All L8 Series B & Shunt Trips	1A @ 480 VAC 2A @ 277 VAC 1.5A @ 125 VDC 2A @ 60 VDC 4A @ 24 VDC	2A @ 230 V (AC-14) 1A @ 400 V (AC-14) 1.5A @ 110 V (DC-12) 1A @ 220 V (DC-12) 4A @ 24 V (DC-13) 2A @ 60 V (DC-13)	1 NO/NC (1 C.O.) 	L8-ASCR3
	Shunt Trip – • Remotely trips the device • Installs on right side of L8 (Series B only) ❷	All L8 Series B	110...415V AC 110...250V DC 12...60V AC/DC	110...415V AC 110...250V DC 12...60V AC/DC		L8-AST1 L8-AST2

L8-ASCR3 Assembly

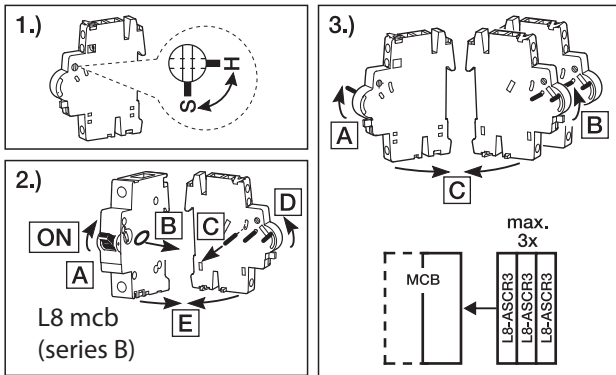

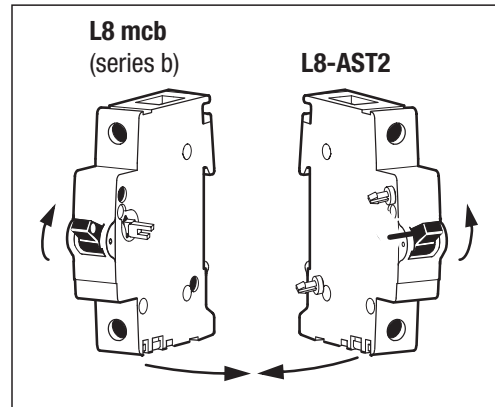

L8-AST1/2 Assembly

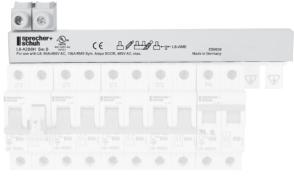
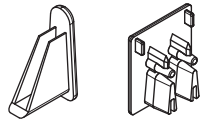
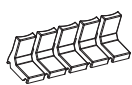
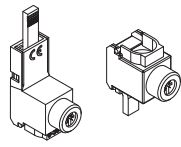
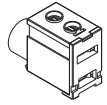

- ❶ A maximum of 3 L8-ASCR3 auxiliary contacts may be installed with or without shunt trip per L8 Series B.
- ❷ A maximum of 3 ASCR3 plus one (1) L8-AST1/2 shunt trip allowed per L8. The shunt must be mounted closest to the L8, then the signal contacts.

Accessories

Accessory	Description	Devices per Meter	For use with...	Catalog Number	
	Bus Bar, Pin Style 1-Phase ②③ Qty 1 bar at 1 meter	57	L8 1-pole, 80A max	L8-A1B8	
				L8 1-pole, 100A max	L8-A1B1
		36	L8 1-pole w/ Aux, 80A max	L8-A1B8H	
			L8 1-pole w/ Aux, 100A max	L8-A1B1H	
	Bus Bar, Pin Style 2-Phase ②③ Qty 1 bar at 1 meter	29	L8 2-pole, 80A max	L8-A2B8	
				L8 2-pole, 100A max	L8-A2B1
		22	L8 2-pole w/ Aux, 80A max	L8-A2B8H	
			L8 2-pole w/ Aux, 100A max	L8-A2B1H	
	Bus Bar, Pin Style 3-Phase ②③ Qty 1 bar at 1 meter	19	L8 3-pole, 80A max	L8-A3B8	
			L8 3-pole, 100A max	L8-A3B1	
16		L8 3-pole w/ Aux, 80A max	L8-A3B8H		
		L8 3-pole w/ Aux, 100A max	L8-A3B1H		
 1-Phase 2- & 3-Phase	End Caps , sold only in pkgs of 10 ①		L8 1-Phase Bus Bar L8 2-/3-Phase Bus Bar	L8-A1E L8-AME	
	Protective Shroud , sold only in pkgs of 10 ①		All L8 bus bars	L8-AAP	
 Straight Low Profile	Terminal Power Feed • Sold only in pkgs of 10 ①		L8 2-/3-Phase Bus Bar Straight Lug 10...1/0 AWG 6...50mm ²	L8-AAT1S	
			L8 1-Phase Bus Bar Offset Lug 10...1/0 AWG low profile 6...50mm ²	L8-AAT1LP	
	Dedicated Power Feed • Sold only in pkgs of 10 ①		All L8 bus bars Offset Lug 14...1 AWG 2.5...50mm ²	L8-AAT2	
 1-pole multi-pole	Lock Out Toggle Mount – • Fits securely over switch toggle. Prevents unauthorized activation of L8 or L9 (series B) during maintenance		L8 or L9 1-pole L8 or L9 Multi-pole (Series B Only)	L8-ALOA1 L8-ALOA2	

① Sold in packages of 10. Minimum order quantity 10.

② Cuttable, copper bus bar provided in 1 m length. UL 508 Listed, E56639, Category NMTR, cULus. CE to IEC 664 10 kA SCCR for use with L8 Supplementary protectors. See page M14 for dimensions.

③ Bus Bars L8- H are designed to accommodate the L8-ASCR3 Auxiliary Contact module, excluding Shunt Trip.

Technical Information
Electrical Ratings

Number of Poles	1, 2, or 3	
Tripping Characteristics	B, C, or D	
Rated Current I_n	0.5...63A	
Rated Frequency f	50/60 Hz	
Rated Insulation voltage U_i acc. to IEC/EN 60664-1	Phase-to-ground	250V AC
	Phase-to-phase	440V AC
Oversvoltage Category	III	
Pollution Degree	3	

Data acc. to UL/CSA ⑤

Rated voltage	1-pole	AC	277V AC
		DC	48V DC
	2-pole	AC	480Y/277V AC
		DC	96V DC
	3-pole	AC	480Y/277V AC
Rated interrupting capacity per UL 1077		≤ 32 A: 10 kA (AC); > 32 A: 5kA (AC); 0.5...63 A: 10 kA (DC)	
Application ①		Supplementary protector for general use; application codes: TC1: [1P] OL0 277V AC, [2P, 3P] OL0 480Y/277V AC; SC: 10 kA (0.5...32 A), 5 kA (35...63 A), U2 480Y/277V AC; FW3	
Reference temperature for tripping characteristics		40°C	
Electrical Endurance		6,000 ops (AC), 6,000 ops. (DC) 1 cycle (1s - ON, 9s - OFF)	

Data acc. to IEC/EN 60947-2

Rated operational voltage U_e	1-pole	230V AC	
	2-, 3-pole	400V AC	
Highest supply or utilization voltage U_{max}	AC	1-pole	253V AC
		2-, 3-pole	440V AC
	DC ②	1-pole	48V DC
		2-pole	96V DC
Min. operating voltage		12V AC/DC	
Rated ultimate short-circuit breaking capacity I_{cu}		15 kA	
Rated service short-circuit breaking capacity I_{cs}	≤ 40 A: 11.25 kA		
	> 40 A: 7.5 kA		
Rated impulse withstand voltage U_{imp} (1.2/50 μs)		4 kV (test voltage 6.2kV at sea level, 5kV at 2,000m)	
Dielectric test voltage		2 kV (50/60Hz, 1 min.)	
Reference temperature for tripping characteristics		30 °C	
Electrical endurance	1 cycle (2s - ON, 13s - OFF, I_n ≤ 32A)	$I_n < 30A$:	20,000 operations (AC)
	1 cycle (2s - ON, 28s - OFF, $I_n > 32A$)	$I_n \geq 30A$:	10,000 ops. (AC); 1,000 ops. (DC)

Mechanical Data

Housing	Insulation group II, RAL 7035
Indicator window	red ON/green OFF
Protection degree per EN 60529	IP20, IP40 in enclosure with cover
Mechanical endurance	20,000 operations
Shock resistance per IEC/EN 60068-2-27	25 g - 2 shocks - 13 ms
Vibration resistance per IEC/EN 60068-2-6	5g - 20 cycles at 5...150...5 Hz with load 0.8 In

Environmental

Environmental conditions (damp heat) per IEC/EN 60068-2-30	28 cycles with 55°C/90-96% and 25°C/95-100%
Ambient temperature ③	-25...+55°C
Storage temperature	-40...+70°C

Installation

Terminal	Dual terminal	
Cross-section of wire – solid, stranded (front/back terminal slot) ④	35/35 mm ²	
	18...4/18...10 AWG	
Flexible	25/10 mm ²	
Multi-wire rating per UL, CSA	1 wire, 18...4 AWG	
	2-4 wires ⑥, 18...10 AWG	
Cross-section of bus bars (top / bottom)	10/10 mm ²	
	IEC	2.8 N•m
Tightening torque	UL/CSA	AWG 18...16: 13.3 in•lb AWG 14...10: 17.7 in•lb AWG 8...4: 39.8 in•lb
Screwdriver	No. 2 Pozidrive	
Mounting	DIN Rail (EN 60715, 35 mm) with fast clip	
Mounting position	Any	
Supply	Optional	

Approximate Dimensions/Weight

Pole dimensions	H x D x W	88 x 69 x 17.5 mm (3.46" x 2.72" x 0.69")
Pole weight		115 g (4.1 oz)

Combination with Auxiliary Elements

Auxiliary contact	Yes
Signal contact	Yes
Shunt trip	Yes

① 2-pole/3-pole single pole load: TC2

② IEC DC Ratings Self-declared

 ③ 35mm² self-declared. Not included in IEC/EN approval.

④ Refer to Ambient Temperature Derating tables.

⑤ UL File E65138

⑥ Wires must be of like size and stranding. Up to two wires per terminal slot.

Power Loss Due to Current

Rated Current [A]	Power Loss Per Pole [W]	Rated Current [A]	Power Loss Per Pole [W]
0.5	1.4	13	2.3
1	1.4	15	2.4
2	1.8	16	2.5
3	1.6	20	2.5
4	1.8	25	3.2
5	1.9	30	3.5
6	2.0	32	3.7
7	1.1	40	4.5
8	1.5	50	4.5
10	2.1	63	5.4

Zero-stack Derating

The installation of several miniature circuit breaker side by side with rated current on all poles requires a correction factor to the rated current (not required if spacers are used).

Number of Adjacent Devices	Factor
1	1
2,3	0.9
4,5	0.8
≥ 6	0.75

L8 Supplementary Protection Devices Ambient Temperature Derating

Note: Application below 0° C is for non-condensing atmosphere. Care should be taken for applications below 0 °C. These devices are not certified to operate correctly in the presence of ice.

Temperature Derating, UL
Reference temperature = 40 °C

Current Rating [A]	Ambient temperature (°C)										
	-25	-20	-10	0	10	20	30	40	50	55	60
0.5	0.6	0.6	0.6	0.6	0.6	0.5	0.5	0.5	0.5	0.5	0.5
1	1.2	1.2	1.2	1.1	1.1	1.1	1.0	1	1.0	0.9	0.9
2	2.5	2.4	2.4	2.3	2.2	2.1	2.1	2	1.9	1.9	1.8
3	3.7	3.7	3.6	3.4	3.3	3.2	3.1	3	2.9	2.8	2.8
4	5.0	4.9	4.7	4.6	4.4	4.3	4.1	4	3.9	3.8	3.7
5	6.2	6.1	5.9	5.7	5.6	5.4	5.2	5	4.8	4.7	4.6
6	7.4	7.3	7.1	6.9	6.7	6.4	6.2	6	5.8	5.7	5.6
7	8.7	8.6	8.3	8.0	7.8	7.5	7.3	7	6.7	6.6	6.5
8	9.9	9.8	9.5	9.2	8.9	8.6	8.3	8	7.7	7.6	7.4
10	12.4	12.2	11.9	11.5	11.1	10.7	10.4	10	9.6	9.4	9.3
13	16.1	15.9	15.4	14.9	14.4	14.0	13.5	13	12.5	12.3	12.0
15	18.6	18.3	17.8	17.2	16.7	16.1	15.6	15	14.4	14.2	13.9
16	19.8	19.6	19.0	18.4	17.8	17.2	16.6	16	15.4	15.1	14.8
20	24.8	24.4	23.7	23.0	22.2	21.5	20.7	20	19.3	18.9	18.5
25	31.0	30.6	29.6	28.7	27.8	26.9	25.9	25	24.1	23.6	23.1
30	37.2	36.7	35.6	34.4	33.3	32.2	31.1	30	28.9	28.3	27.8
32	39.7	39.1	37.9	36.7	35.6	34.4	33.2	32	30.8	30.2	29.6
40	49.6	48.9	47.4	45.9	44.4	43.0	41.5	40	38.5	37.8	37.0
50	62.0	61.1	59.3	57.4	55.6	53.7	51.9	50	48.2	47.2	46.3
63	78.2	77.0	74.7	72.3	70.0	67.7	65.3	63	60.7	59.5	58.3

Temperature Derating, IEC
Reference temperature = 30 °C

Current Rating [A]	Ambient temperature (°C)										
	-25	-20	-10	0	10	20	30	40	50	55	60
0.5	0.6	0.6	0.6	0.5	0.5	0.5	0.5	0.5	0.5	0.5	0.5
1	1.2	1.2	1.1	1.1	1.1	1.0	1	1.0	0.9	0.9	0.9
2	2.3	2.3	2.2	2.2	2.1	2.1	2	1.9	1.9	1.9	1.8
3	3.5	3.5	3.4	3.3	3.2	3.1	3	2.9	2.8	2.8	2.7
4	4.7	4.6	4.5	4.4	4.2	4.1	4	3.9	3.8	3.7	3.6
5	5.8	5.8	5.6	5.5	5.3	5.2	5	4.9	4.7	4.6	4.5
6	7.0	6.9	6.7	6.5	6.4	6.2	6	5.8	5.6	5.6	5.5
7	8.2	8.1	7.8	7.6	7.4	7.2	7	6.8	6.6	6.5	6.4
8	9.3	9.2	9.0	8.7	8.5	8.2	8	7.8	7.5	7.4	7.3
10	11.7	11.5	11.2	10.9	10.6	10.3	10	9.7	9.4	9.3	9.1
13	15.1	15.0	14.6	14.2	13.8	13.4	13	12.6	12.2	12.0	11.8
15	17.5	17.3	16.8	16.4	15.9	15.5	15	14.6	14.1	13.9	13.6
16	18.6	18.4	17.9	17.4	17.0	16.5	16	15.5	15.0	14.8	14.6
20	23.3	23.0	22.4	21.8	21.2	20.6	20	19.4	18.8	18.5	18.2
25	29.1	28.8	28.0	27.3	26.5	25.8	25	24.3	23.5	23.1	22.7
30	35.0	34.5	33.6	32.7	31.8	30.9	30	29.1	28.2	27.8	27.3
32	37.3	36.8	35.8	34.9	33.9	33.0	32	31.0	30.1	29.6	29.1
40	46.6	46.0	44.8	43.6	42.4	41.2	40	38.8	37.6	37.0	36.4
50	58.3	57.5	56.0	54.5	53.0	51.5	50	48.5	47.0	46.3	45.5
63	73.4	72.5	70.6	68.7	66.8	64.9	63	61.1	59.2	58.3	57.3

Note: In order to use MCB at 60°C you must use cable suitable for this temperature. Any third party certifications are not covering this ambient temperature rating.

M L8 Supplementary Protectors

Tripping Characteristics - B and C Curve

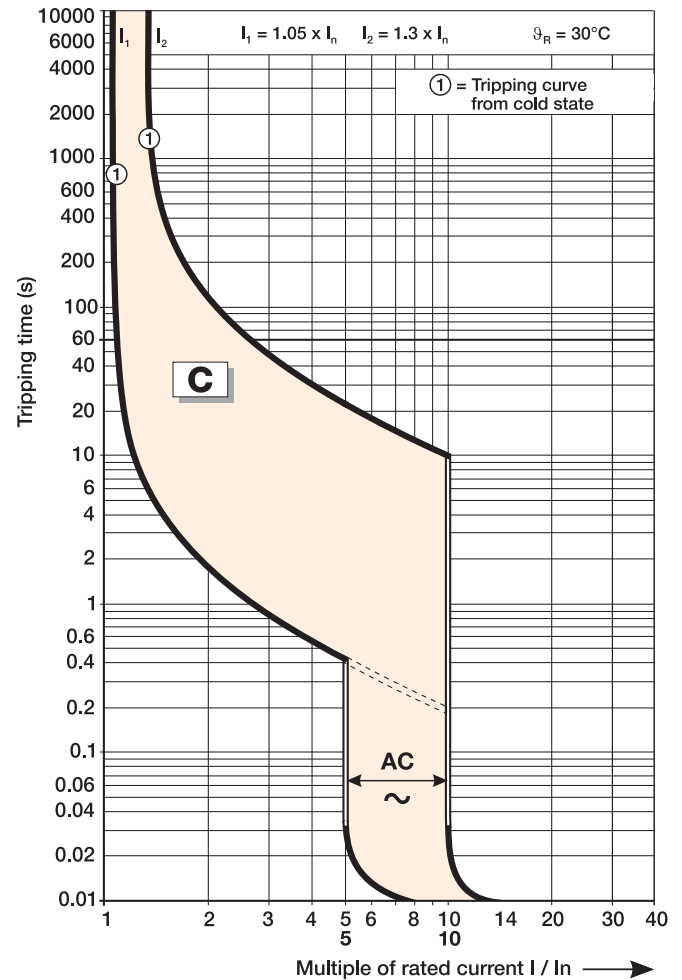
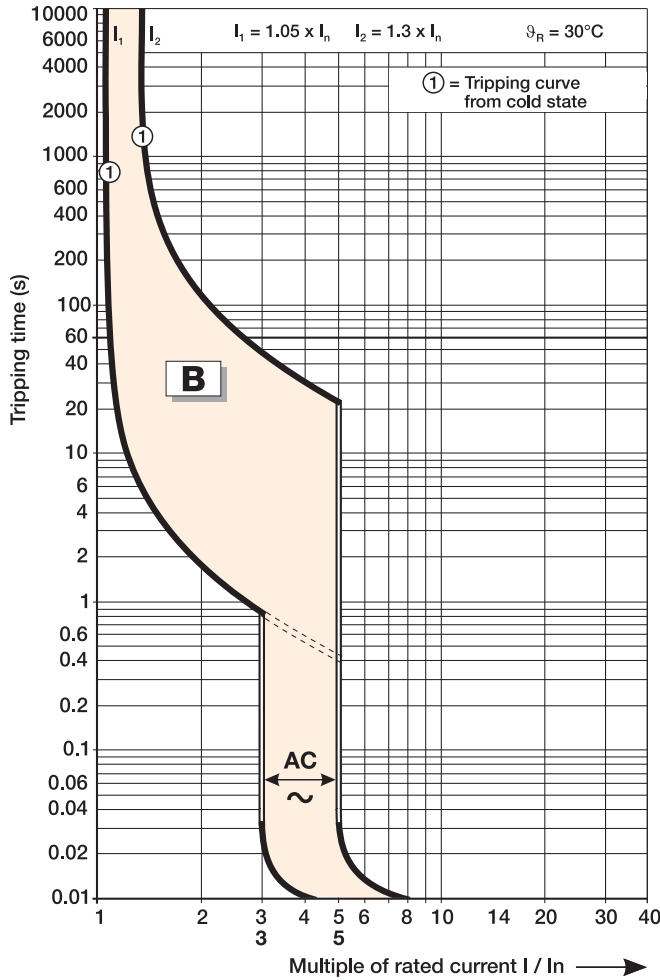

B and C Curve - 230/400V AC Let-through Energy

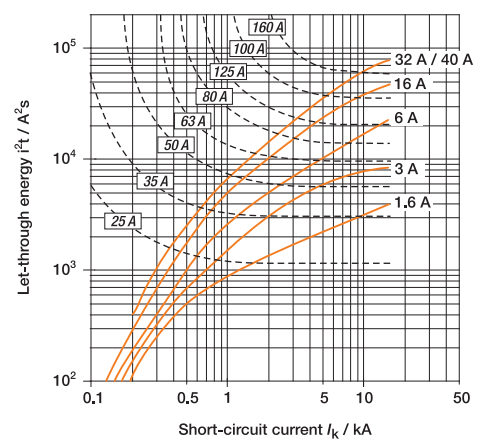
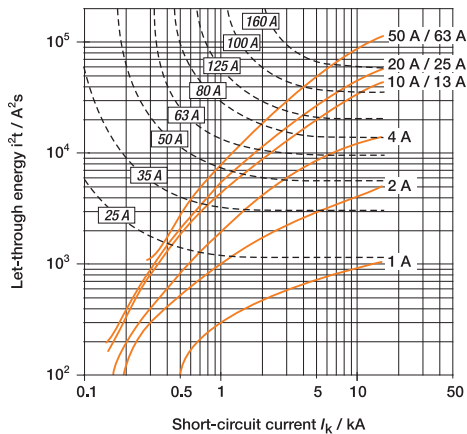

Tripping Characteristics - D Curve

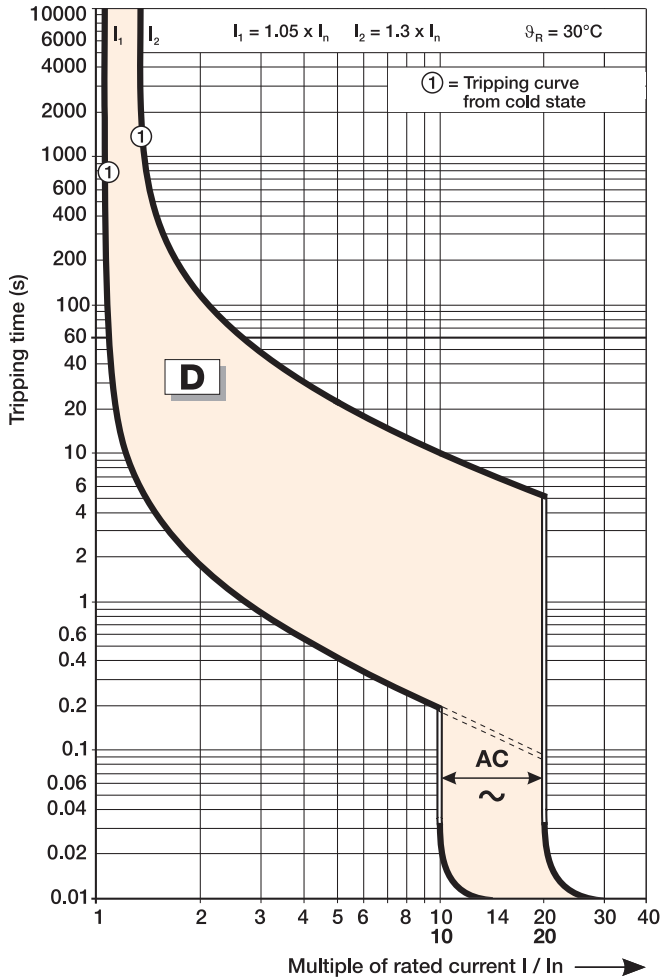

D Curve - 230/400V AC Let-through Energy

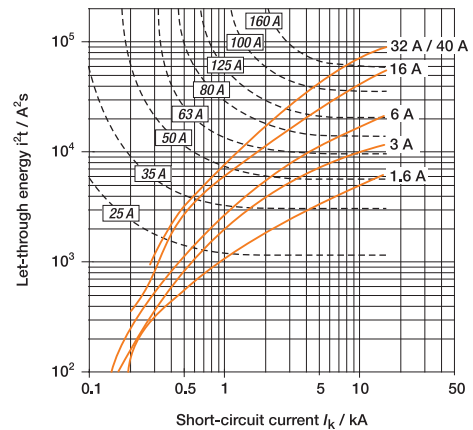
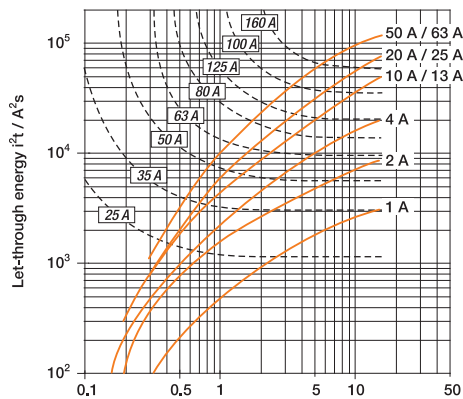

L8 Supplementary Protectors (Curve B, C & D)

Dimensions are in millimeters (inches). Dimensions not intended for manufacturing purposes.

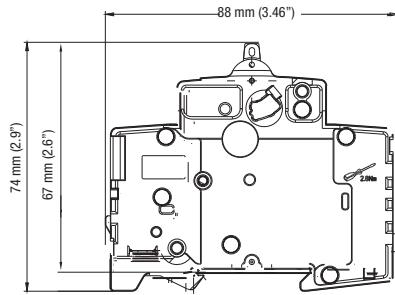

1-Pole

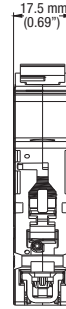

1-Pole

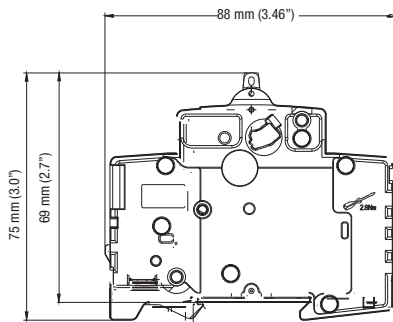

2- & 3-Pole

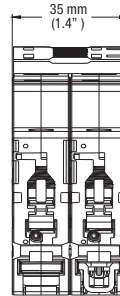

2-Pole

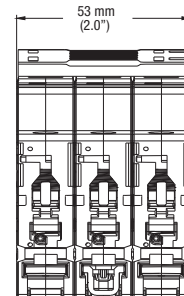

3-Pole

Auxiliary Contact/Signal Alarm (L8-ASCR3)

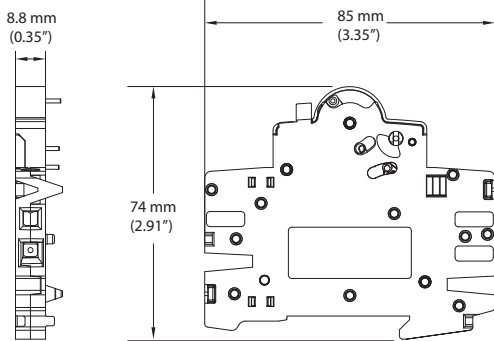

Shunt Trip Modules (L8-AST1/2)

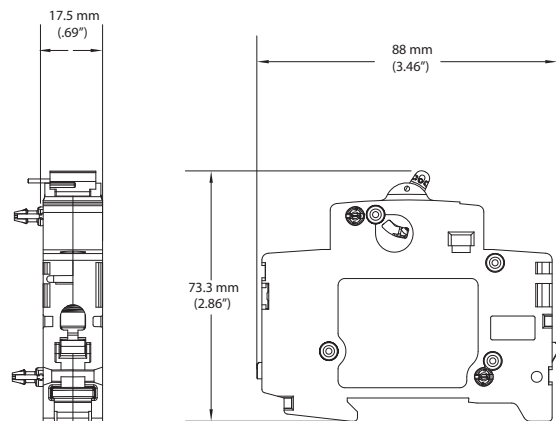

L8 - 1-Pole Bus Bars (L8-A1B...)

Dimensions are in millimeters (inches). Dimensions not intended for manufacturing purposes.

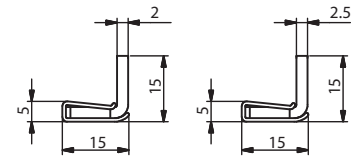
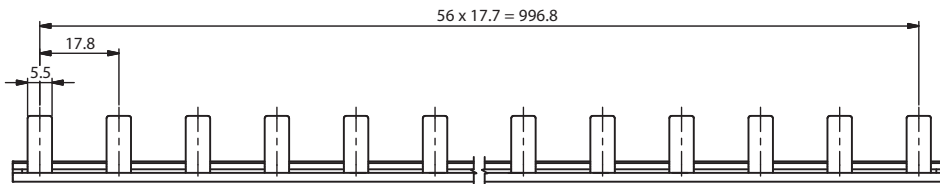
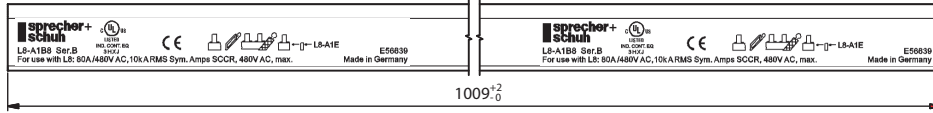

L8-A1B8

L8-A1B1

L8 - 1-Pole Bus Bars with Auxiliary (L8-A1B...H)

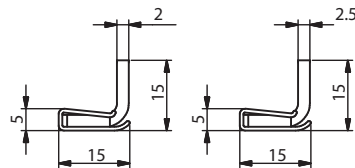
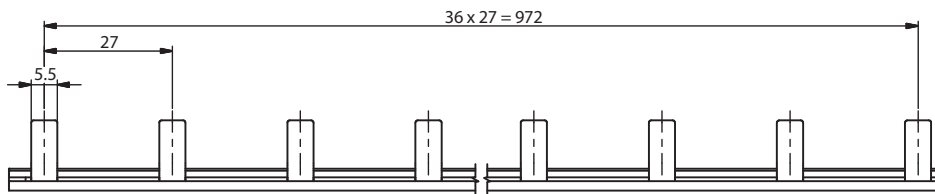
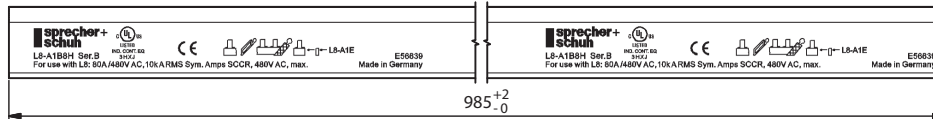

L8-A1B8H

L8-A1B1H



L8 Supplementary Protectors

L8-A2B8 - 2 Pole Bus Bars

Dimensions are in millimeters (inches). Dimensions not intended for manufacturing purposes.

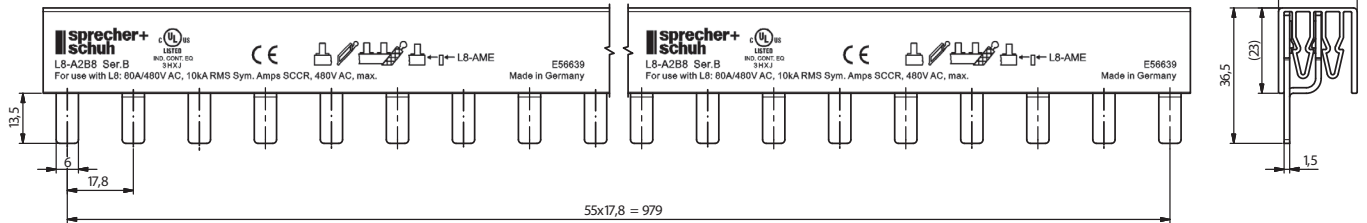

L8-A2B1 - 2 Pole Bus Bars

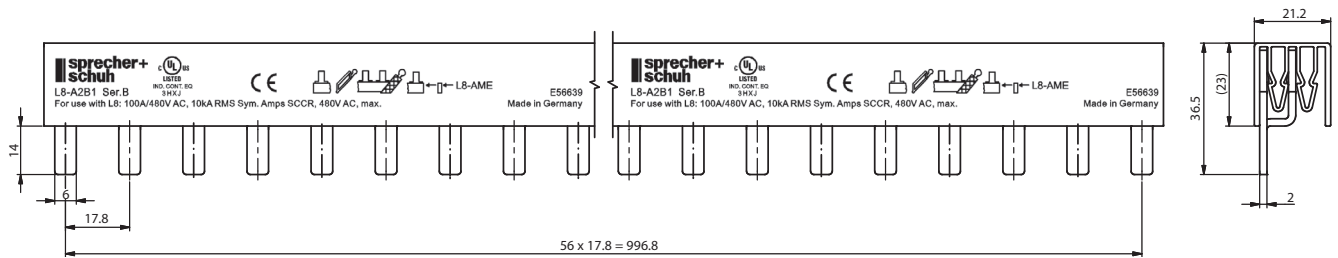
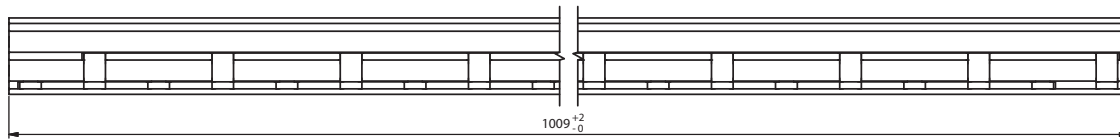

L8-A2B8H - 2 Pole Bus Bars w/ Auxiliary

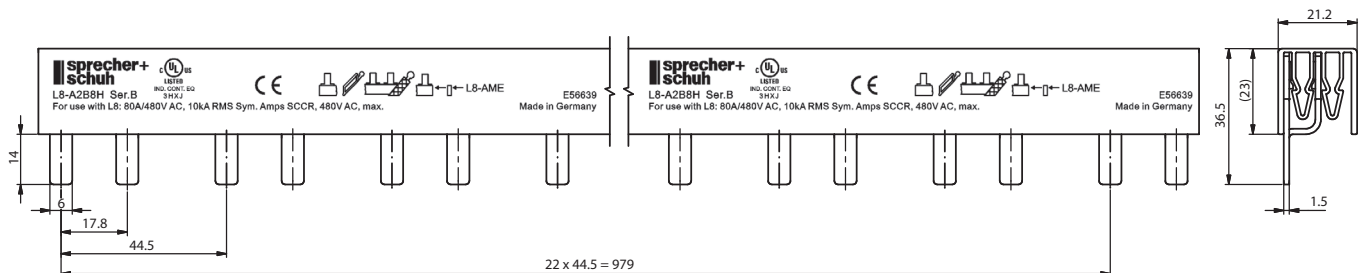
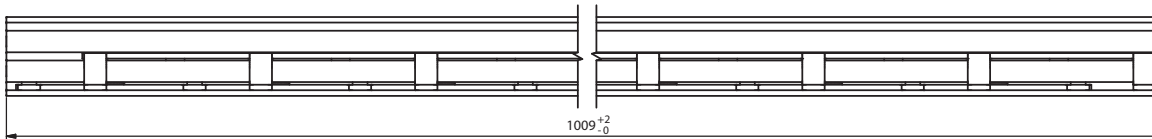

L8 Supplementary Protectors

L8-A2B1H - 2 Pole Bus Bars w/ Auxiliary

Dimensions are in millimeters (inches). Dimensions not intended for manufacturing purposes.

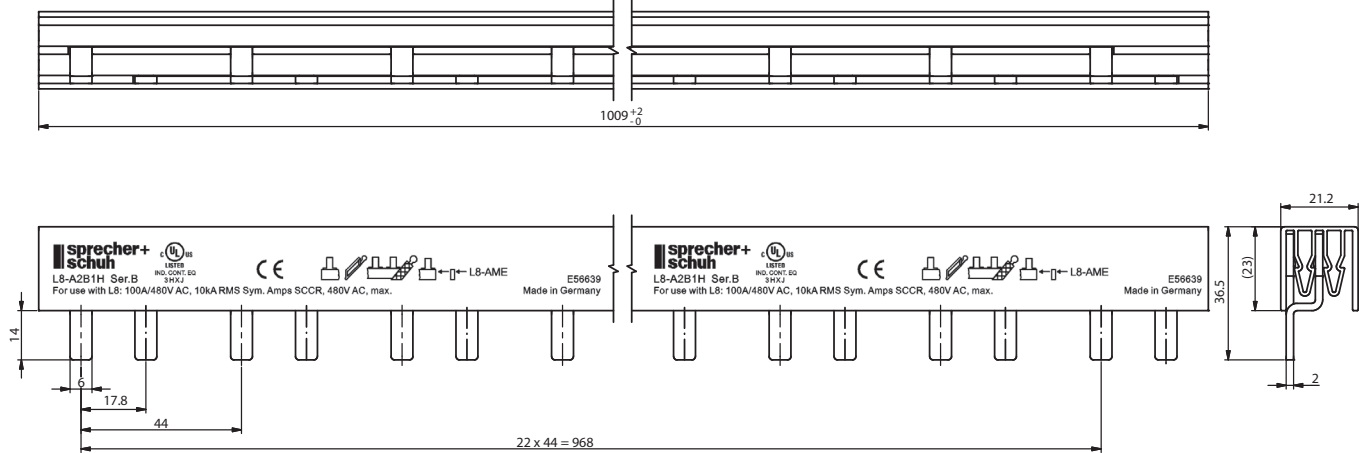

L8-A3B8 - 3 Pole Bus Bars

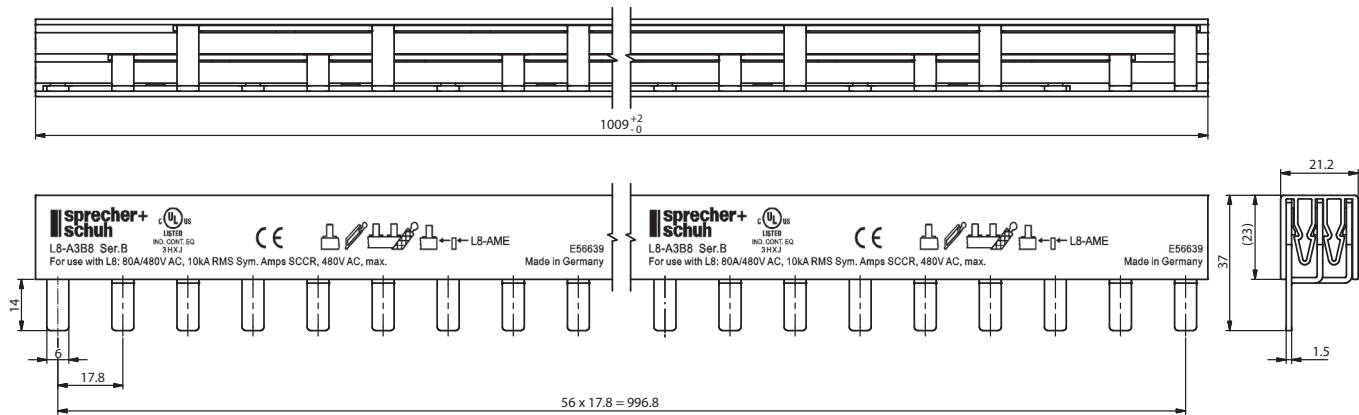

L8-A3B1 - 3 Pole Bus Bars

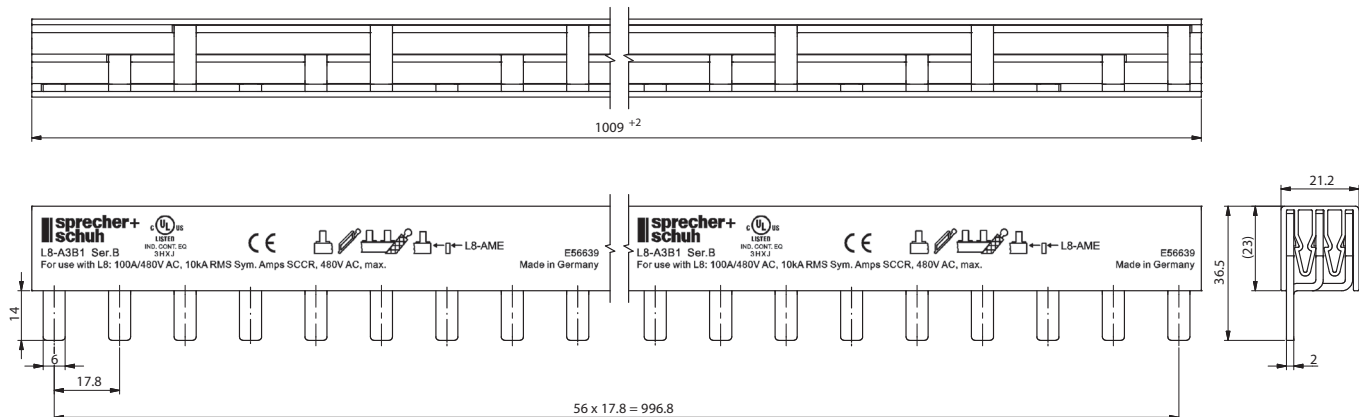

L8 Supplementary Protectors

L8-A3B8H - 3 Pole Bus Bars w/ Auxiliary

Dimensions are in millimeters (inches). Dimensions not intended for manufacturing purposes.

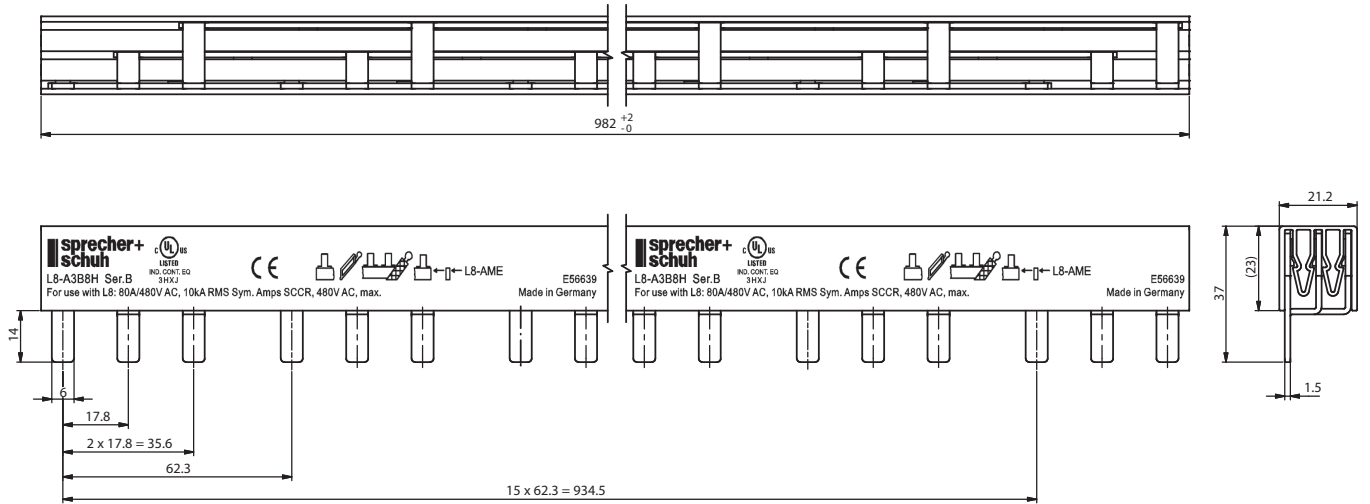

L8-A3B1H - 3 Pole Bus Bars w/ Auxiliary

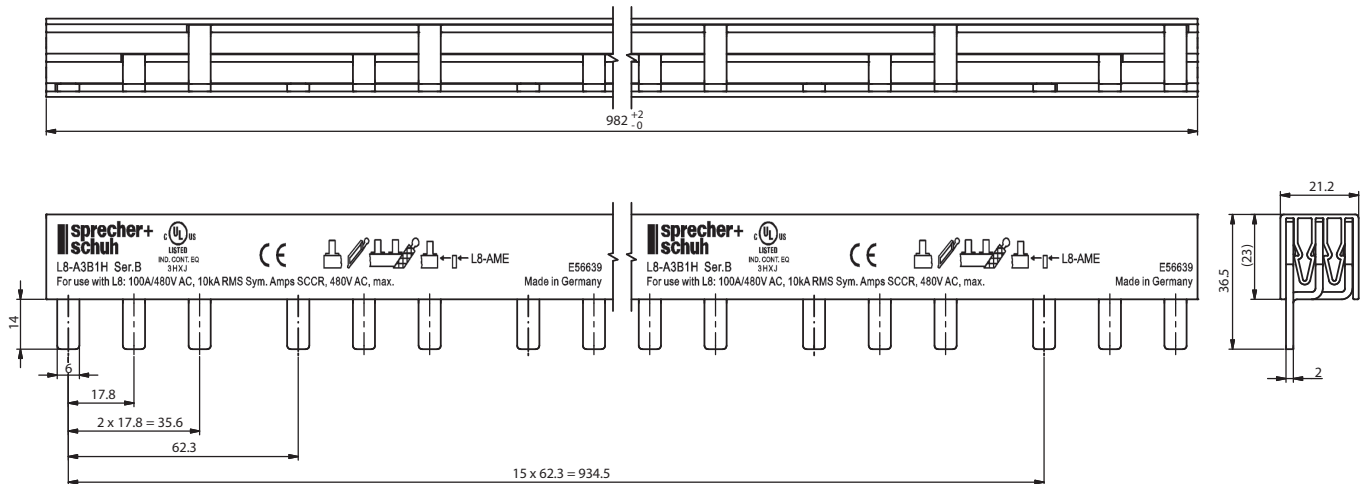

L8-AAP - Protective Shroud

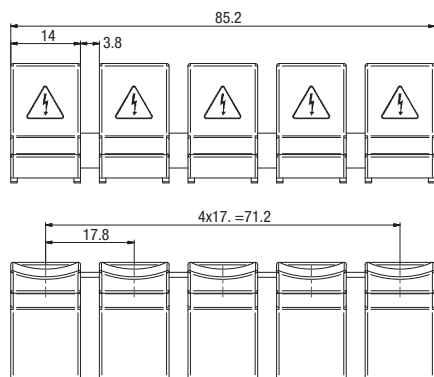

L8-A1E - End Cap 1-Phase

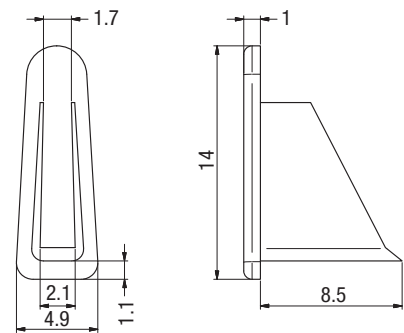

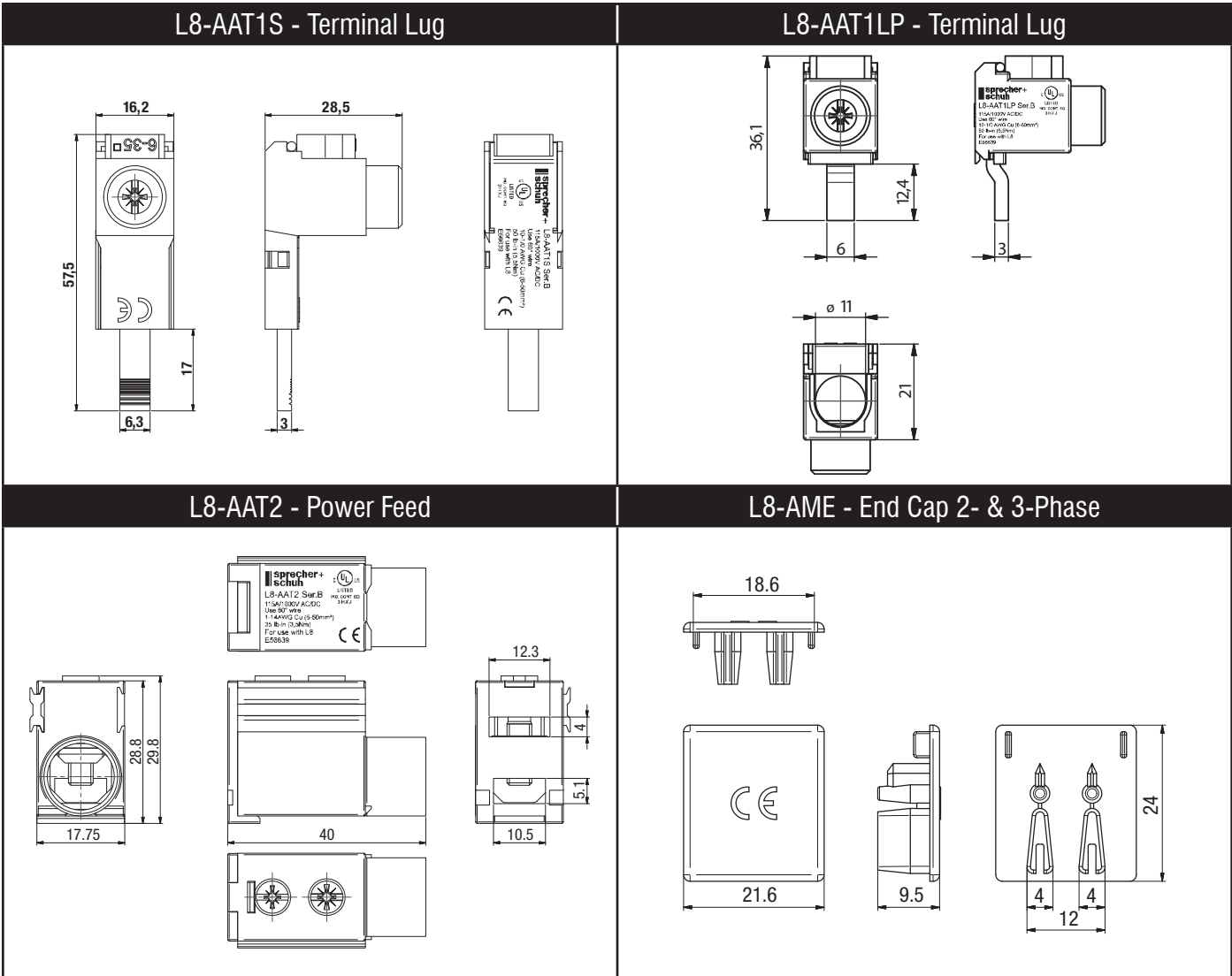

Applying L8 Bus Bars & Accessories

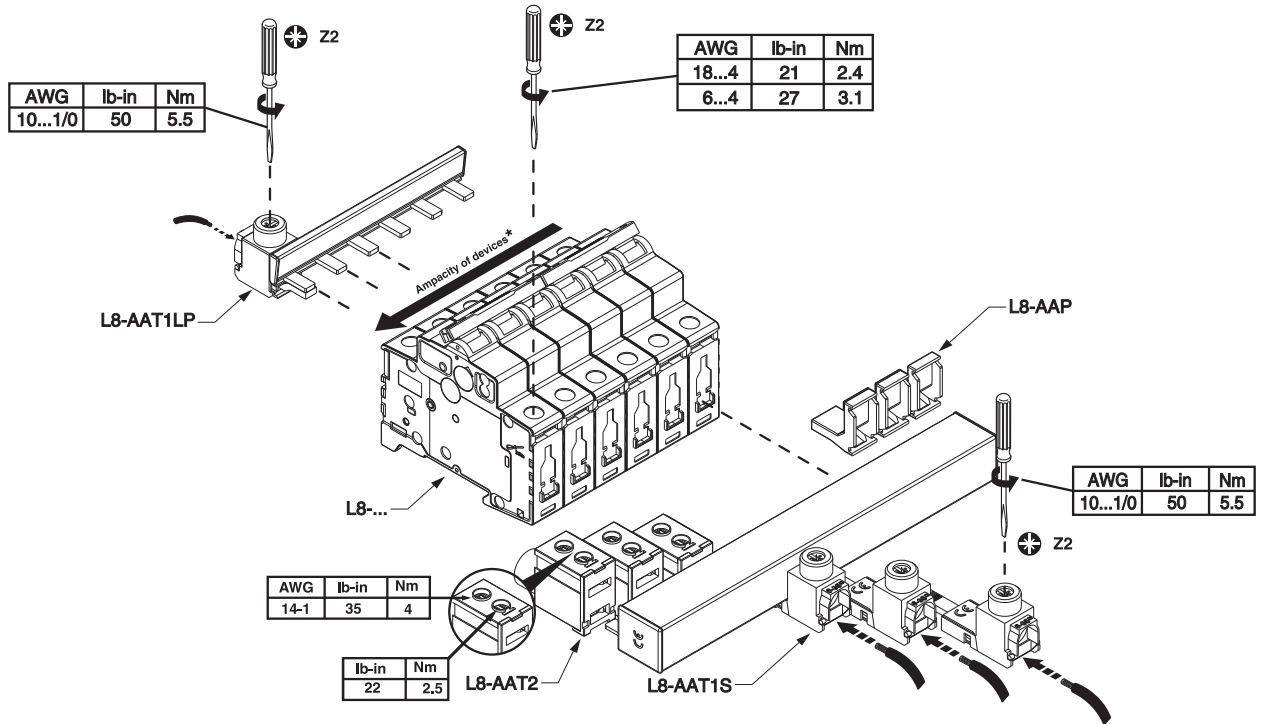

80AMP

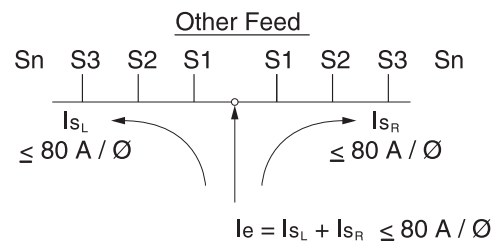
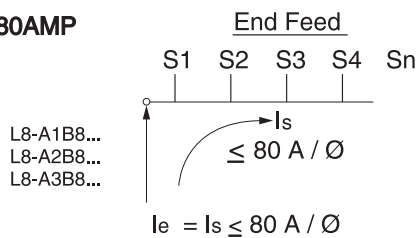

100AMP

