



Selection and ordering data

5SJ4 Miniature Circuit Breaker Guide			
	Catalog Series	5SJ41...-.HG40	5SJ4...-.HG41
Rated Voltage	240, 120 VAC 60 VDC Same Polarity	240 VAC 60/125 VDC	480Y/277 VAC 60/125 VDC
Number of Poles	1-Pole	1-, 2- and 3-Poles	
Trip Characteristics	B, C, D	C, D	
Rated Current	B Characteristic: 6 to 63 A C and D Characteristic: 0.3 to 63 A		C Characteristic: 0.3 to 40 A D Characteristic: 0.3 to 32 A
Interrupting Ratings¹⁾	B Characteristic: 14 kA (6 to 63 A)	—	—
	C Characteristic: 14 kA (0.3 to 40 A) 10 kA (45 to 63 A)	C Characteristic: 10 kA (0.3 to 40 A) ²⁾	
	D Characteristic: 14 kA (0.3 to 20 A) 10 kA (25 to 63 A)	D Characteristic: 10 kA (0.3 to 32 A) ²⁾	

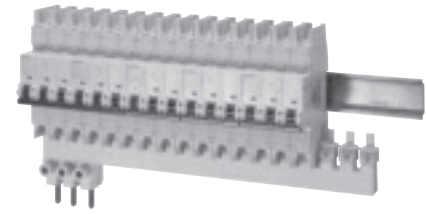

5SJ4...-.HG41 Miniature Circuit Breakers

Certifications:

CE
UL Listed and Certified to Canadian
Standards
HACR Rated

1) 14 kA = Type HSJ; 10 kA = Type NSJ.

2) At 240 VAC the Interrupting Rating is the same as the 5SJ4...-.HG40 and .HG41.

Features

Features – UL 489

- Suitable for Branch Circuit Protection Applications up to 277 VAC and 60 VDC (1-pole); and, up to 480Y VAC and 125 VDC (2- and 3-pole)
- UL Listed and Certified to Canadian Standards, File E243414
- HACR Rated
- High AC Interrupting Ratings of up to 14,000 (Type HSJ) or 10,000 (Type NSJ) Maximum RMS Symmetrical Amps and, DC interrupting ratings of 10,000 Amps
- 40°C Calibration Base (Industrial Applications)
- Can be used for "field wiring" applications; AWG 14 to AWG 4, Copper (Cu) Only
- Suitable for "reverse feed" applications

Features – EN/IEC 60 898

- 30°C Calibration Base
- Trip Characteristic B, C and D
B: Designed for the protection of computers and electronic equipment. Magnetic trip point is 3 to 5 times the MCB rating.
C: Designed for general device protection in control circuits and all other miniature circuit breaker systems. Magnetic trip point is 5 to 10 times the MCB rating.
D: Designed for high inrush loads. Magnetic trip point is 10 to 20 times the MCB rating.
- Rated voltage of 24 VAC minimum, 440 VAC Maximum and 60 VDC per pole
- High Interrupting Rating (I_{cn}) of up to 10,000 Amps
- 0.75 to 35 mm² solid and stranded conductors

Features – Common

- Depending on the device selected
- Available with 1-, 2- or 3-poles
- Available from 0.3 to 63 amps
- Visible Indicator for ON and OFF/Trip
- Touch Protection to EN50274
- DIN Rail Mounting (Standard 35 mm)
- Identical Wire Screw Connections on Line and Load Sides
- Smaller Size than traditional MCCB's

Auxiliary Circuit Switches (AS) are available with One Normally Open + One Normally Closed, Two Normally Open or Two Normally Closed contacts. They are primarily used to signal the miniature circuit breaker's trip mechanism position.

Fault Signal Contacts (FC) are available with One Normally Open + One Normally Closed, Two Normally Open or Two Normally Closed contacts. They are primarily used to signal the automatic tripping of the miniature circuit breaker's trip mechanism; and, trip position.

Shunt Trip Switches (ST) are available in voltages of 110 to 480 VAC and 24 to 60 V AC/DC. They are used for remote tripping of a miniature circuit breaker.

5ST366...-HG busbars, touch protection covers and terminal connectors are intended for use with Siemens lines of 5SJ4...-.HG4. UL 489 Miniature Circuit Breakers. They are UL Recognized (File E32159) with a rating of 115 Amps maximum at 480Y/277 VAC. Busbars are available in 1-, 2- or 3-pole versions.

Touch Protection Covers are used to cover any unused busbar terminals. They are intended to protect a user from live electrical parts.

Terminal Connectors are used to connect electrical conductors up to 1 AWG (50mm²) to the busbar terminals. Two versions are available; connect directly to the miniature circuit breaker or direct connection to the busbar.

Control Circuit Protection

5SJ Branch Circuit Protection

5SJ4 70 mm mounting depth

Features

5SJ41...HG40 miniature circuit breakers are designed to comply with UL 489 and CSA 22.2 No. 5-02 standards. They are used in single pole, branch circuit protection applications up to 240 VAC maximum and 60 VDC maximum, same polarity. Refer to Technical Data (page 16/8) for additional information.

Selection and ordering data

	I_n	Characteristic B			Characteristic C			Characteristic D			Weight 1 Item kg
		Order No.	Inter- ruption Type ¹⁾	List Price \$ 1 item	Order No.	Inter- ruption Type ¹⁾	List Price \$ 1 item	Order No.	Inter- ruption Type ¹⁾	List Price \$ 1 item	
	0.3	—	—	—	5SJ4114-7HG40	HSJ	—	5SJ4114-8HG40	HSJ	—	0.155
	0.5	—	—	—	5SJ4105-7HG40	HSJ	—	5SJ4105-8HG40	HSJ	—	
	1	—	—	—	5SJ4101-7HG40	HSJ	—	5SJ4101-8HG40	HSJ	—	
	1.6	—	—	—	5SJ4115-7HG40	HSJ	—	5SJ4115-8HG40	HSJ	—	
	2	—	—	—	5SJ4102-7HG40	HSJ	—	5SJ4102-8HG40	HSJ	—	
	3	—	—	—	5SJ4103-7HG40	HSJ	—	5SJ4103-8HG40	HSJ	—	
	4	—	—	—	5SJ4104-7HG40	HSJ	—	5SJ4104-8HG40	HSJ	—	
	5	—	—	—	5SJ4111-7HG40	HSJ	—	5SJ4111-8HG40	HSJ	—	
	6	5SJ4106-6HG40	HSJ	—	5SJ4106-7HG40	HSJ	—	5SJ4106-8HG40	HSJ	—	
	8	—	—	—	5SJ4108-7HG40	HSJ	—	5SJ4108-8HG40	HSJ	—	
	10	5SJ4110-6HG40	HSJ	—	5SJ4110-7HG40	HSJ	—	5SJ4110-8HG40	HSJ	—	
	13	5SJ4113-6HG40	HSJ	—	5SJ4113-7HG40	HSJ	—	5SJ4113-8HG40	HSJ	—	
	15	5SJ4118-6HG40	HSJ	—	5SJ4118-7HG40	HSJ	—	5SJ4118-8HG40	HSJ	—	
	16	5SJ4116-6HG40	HSJ	—	5SJ4116-7HG40	HSJ	—	5SJ4116-8HG40	HSJ	—	
	20	5SJ4120-6HG40	HSJ	—	5SJ4120-7HG40	HSJ	—	5SJ4120-8HG40	HSJ	—	
	25	5SJ4125-6HG40	HSJ	—	5SJ4125-7HG40	HSJ	—	5SJ4125-8HG40	NSJ	—	
	30	5SJ4130-6HG40	HSJ	—	5SJ4130-7HG40	HSJ	—	5SJ4130-8HG40	NSJ	—	
	32	5SJ4132-6HG40	HSJ	—	5SJ4132-7HG40	HSJ	—	5SJ4132-8HG40	NSJ	—	
	35	5SJ4135-6HG40	HSJ	—	5SJ4135-7HG40	HSJ	—	5SJ4135-8HG40	NSJ	—	
	40	5SJ4140-6HG40	HSJ	—	5SJ4140-7HG40	HSJ	—	5SJ4140-8HG40	NSJ	—	
45	5SJ4145-6HG40	HSJ	—	5SJ4145-7HG40	NSJ	—	5SJ4145-8HG40	NSJ	—		
50	5SJ4150-6HG40	HSJ	—	5SJ4150-7HG40	NSJ	—	5SJ4150-8HG40	NSJ	—		
60	5SJ4160-6HG40	HSJ	—	5SJ4160-7HG40	NSJ	—	5SJ4160-8HG40	NSJ	—		
63	5SJ4163-6HG40	HSJ	—	5SJ4163-7HG40	NSJ	—	5SJ4163-8HG40	NSJ	—		

1) Interrupting Rating to UL489, AC Max. RMS Symmetrical: Type NSJ = 10kA, Type HSJ = 14 kA.

Control Circuit Protection



5SJ Branch Circuit Protection

5SJ4 70 mm mounting depth

Features

5SJ4...-HG41 miniature circuit breakers are designed to comply with UL 489 and CSA 22.2 No. 5-02 standards. They are used in single and multi-pole, branch circuit protection applications up to 240 VAC maximum and 60/125 VDC maximum. Refer to Technical Data (page 16/8) for additional information.

Selection and ordering data

	I_n	Characteristic C			Characteristic D			Weight 1 item kg
		Order No.	Interruption Type ¹⁾	List Price \$ 1 item	Order No.	Interruption Type ¹⁾	List Price \$ 1 item	
 <p>1-pole</p> <p>1 2</p>	0.3	5SJ4114-7HG41	HSJ	5SJ4114-8HG41	HSJ	0.155		
	0.5	5SJ4105-7HG41	HSJ	5SJ4105-8HG41	HSJ			
	1	5SJ4101-7HG41	HSJ	5SJ4101-8HG41	HSJ			
	1.6	5SJ4115-7HG41	HSJ	5SJ4115-8HG41	HSJ			
	2	5SJ4102-7HG41	HSJ	5SJ4102-8HG41	HSJ			
	3	5SJ4103-7HG41	HSJ	5SJ4103-8HG41	HSJ			
	4	5SJ4104-7HG41	HSJ	5SJ4104-8HG41	HSJ			
	5	5SJ4111-7HG41	HSJ	5SJ4111-8HG41	HSJ			
	6	5SJ4106-7HG41	HSJ	5SJ4106-8HG41	HSJ			
	8	5SJ4108-7HG41	HSJ	5SJ4108-8HG41	HSJ			
	10	5SJ4110-7HG41	HSJ	5SJ4110-8HG41	HSJ			
	13	5SJ4113-7HG41	HSJ	5SJ4113-8HG41	HSJ			
	15	5SJ4118-7HG41	HSJ	5SJ4118-8HG41	HSJ			
	16	5SJ4116-7HG41	HSJ	5SJ4116-8HG41	HSJ			
	20	5SJ4120-7HG41	HSJ	5SJ4120-8HG41	HSJ			
	25	5SJ4125-7HG41	HSJ	5SJ4125-8HG41	NSJ			
	30	5SJ4130-7HG41	HSJ	5SJ4130-8HG41	NSJ			
	32	5SJ4132-7HG41	HSJ	5SJ4132-8HG41	NSJ			
	35	5SJ4135-7HG41	HSJ	5SJ4135-8HG41	NSJ			
40	5SJ4140-7HG41	HSJ	5SJ4140-8HG41	NSJ				
45	5SJ4145-7HG41	NSJ	5SJ4145-8HG41	NSJ				
50	5SJ4150-7HG41	NSJ	5SJ4150-8HG41	NSJ				
60	5SJ4160-7HG41	NSJ	5SJ4160-8HG41	NSJ				
63	5SJ4163-7HG41	NSJ	5SJ4163-8HG41	NSJ				
 <p>2-pole</p> <p>1 3 2 4</p>	0.3	5SJ4214-7HG41	HSJ	5SJ4214-8HG41	HSJ	0.310		
	0.5	5SJ4205-7HG41	HSJ	5SJ4205-8HG41	HSJ			
	1	5SJ4201-7HG41	HSJ	5SJ4201-8HG41	HSJ			
	1.6	5SJ4215-7HG41	HSJ	5SJ4215-8HG41	HSJ			
	2	5SJ4202-7HG41	HSJ	5SJ4202-8HG41	HSJ			
	3	5SJ4203-7HG41	HSJ	5SJ4203-8HG41	HSJ			
	4	5SJ4204-7HG41	HSJ	5SJ4204-8HG41	HSJ			
	5	5SJ4211-7HG41	HSJ	5SJ4211-8HG41	HSJ			
	6	5SJ4206-7HG41	HSJ	5SJ4206-8HG41	HSJ			
	8	5SJ4208-7HG41	HSJ	5SJ4208-8HG41	HSJ			
	10	5SJ4210-7HG41	HSJ	5SJ4210-8HG41	HSJ			
	13	5SJ4213-7HG41	HSJ	5SJ4213-8HG41	HSJ			
	15	5SJ4218-7HG41	HSJ	5SJ4218-8HG41	HSJ			
	16	5SJ4216-7HG41	HSJ	5SJ4216-8HG41	HSJ			
	20	5SJ4220-7HG41	HSJ	5SJ4220-8HG41	HSJ			
	25	5SJ4225-7HG41	HSJ	5SJ4225-8HG41	NSJ			
	30	5SJ4230-7HG41	HSJ	5SJ4230-8HG41	NSJ			
	32	5SJ4232-7HG41	HSJ	5SJ4232-8HG41	NSJ			
	35	5SJ4235-7HG41	HSJ	5SJ4235-8HG41	NSJ			
40	5SJ4240-7HG41	HSJ	5SJ4240-8HG41	NSJ				
45	5SJ4245-7HG41	NSJ	5SJ4245-8HG41	NSJ				
50	5SJ4250-7HG41	NSJ	5SJ4250-8HG41	NSJ				
60	5SJ4260-7HG41	NSJ	5SJ4260-8HG41	NSJ				
63	5SJ4263-7HG41	NSJ	5SJ4263-8HG41	NSJ				
 <p>3-pole</p> <p>1 3 5 2 4 6</p>	0.3	5SJ4314-7HG41	HSJ	5SJ4314-8HG41	HSJ	0.465		
	0.5	5SJ4305-7HG41	HSJ	5SJ4305-8HG41	HSJ			
	1	5SJ4301-7HG41	HSJ	5SJ4301-8HG41	HSJ			
	1.6	5SJ4315-7HG41	HSJ	5SJ4315-8HG41	HSJ			
	2	5SJ4302-7HG41	HSJ	5SJ4302-8HG41	HSJ			
	3	5SJ4303-7HG41	HSJ	5SJ4303-8HG41	HSJ			
	4	5SJ4304-7HG41	HSJ	5SJ4304-8HG41	HSJ			
	5	5SJ4311-7HG41	HSJ	5SJ4311-8HG41	HSJ			
	6	5SJ4306-7HG41	HSJ	5SJ4306-8HG41	HSJ			
	8	5SJ4308-7HG41	HSJ	5SJ4308-8HG41	HSJ			
	10	5SJ4310-7HG41	HSJ	5SJ4310-8HG41	HSJ			
	13	5SJ4313-7HG41	HSJ	5SJ4313-8HG41	HSJ			
	15	5SJ4318-7HG41	HSJ	5SJ4318-8HG41	HSJ			
	16	5SJ4316-7HG41	HSJ	5SJ4316-8HG41	HSJ			
	20	5SJ4320-7HG41	HSJ	5SJ4320-8HG41	HSJ			
	25	5SJ4325-7HG41	HSJ	5SJ4325-8HG41	NSJ			
	30	5SJ4330-7HG41	HSJ	5SJ4330-8HG41	NSJ			
	32	5SJ4332-7HG41	HSJ	5SJ4332-8HG41	NSJ			
	35	5SJ4335-7HG41	HSJ	5SJ4335-8HG41	NSJ			
40	5SJ4340-7HG41	HSJ	5SJ4340-8HG41	NSJ				
45	5SJ4345-7HG41	NSJ	5SJ4345-8HG41	NSJ				
50	5SJ4350-7HG41	NSJ	5SJ4350-8HG41	NSJ				
60	5SJ4360-7HG41	NSJ	5SJ4360-8HG41	NSJ				
63	5SJ4363-7HG41	NSJ	5SJ4363-8HG41	NSJ				

1) Interrupting Rating to UL489, AC Max. RMS Symmetrical: Type NSJ = 10kA, Type HSJ = 14 kA.

Control Circuit Protection



5SJ Branch Circuit Protection

5SJ4 70 mm mounting depth

Features

5SJ4...-HG42 miniature circuit breakers are designed to comply with UL 489 and CSA 22.2 No. 5-02 standards. They are used in single and multi-pole, branch circuit protection and feeder applications up to 480Y/277 VAC maximum and 60/125 VDC maximum. Refer to Technical Data (page 16/8) for additional information.

Selection and ordering data

	I_n	Characteristic C			Characteristic D			Weight 1 item kg
		Order No.	Interruption Type 1)	List Price \$ 1 item	Order No.	Interruption Type 1)	List Price \$ 1 item	
 <p>1-pole</p> <p>*1 1 2</p>	A							
	0.3	5SJ4114-7HG42	NSJ		5SJ4114-8HG42	NSJ		0.155
	0.5	5SJ4105-7HG42	NSJ		5SJ4105-8HG42	NSJ		
	1	5SJ4101-7HG42	NSJ		5SJ4101-8HG42	NSJ		
	1.6	5SJ4115-7HG42	NSJ		5SJ4115-8HG42	NSJ		
	2	5SJ4102-7HG42	NSJ		5SJ4102-8HG42	NSJ		
	3	5SJ4103-7HG42	NSJ		5SJ4103-8HG42	NSJ		
	4	5SJ4104-7HG42	NSJ		5SJ4104-8HG42	NSJ		
	5	5SJ4111-7HG42	NSJ		5SJ4111-8HG42	NSJ		
	6	5SJ4106-7HG42	NSJ		5SJ4106-8HG42	NSJ		
	8	5SJ4108-7HG42	NSJ		5SJ4108-8HG42	NSJ		
	10	5SJ4110-7HG42	NSJ		5SJ4110-8HG42	NSJ		
	13	5SJ4113-7HG42	NSJ		5SJ4113-8HG42	NSJ		
	15	5SJ4118-7HG42	NSJ		5SJ4118-8HG42	NSJ		
	16	5SJ4116-7HG42	NSJ		5SJ4116-8HG42	NSJ		
	20	5SJ4120-7HG42	NSJ		5SJ4120-8HG42	NSJ		
	25	5SJ4125-7HG42	NSJ		5SJ4125-8HG42	NSJ		
30	5SJ4130-7HG42	NSJ		5SJ4130-8HG42	NSJ			
32	5SJ4132-7HG42	NSJ		5SJ4132-8HG42	NSJ			
35	5SJ4135-7HG42	NSJ		—	—			
40	5SJ4140-7HG42	NSJ		—	—			
 <p>2-pole</p> <p>*1 *3 1 2 4</p>	0.3	5SJ4214-7HG42	NSJ		5SJ4214-8HG42	NSJ	0.310	
	0.5	5SJ4205-7HG42	NSJ		5SJ4205-8HG42	NSJ		
	1	5SJ4201-7HG42	NSJ		5SJ4201-8HG42	NSJ		
	1.6	5SJ4215-7HG42	NSJ		5SJ4215-8HG42	NSJ		
	2	5SJ4202-7HG42	NSJ		5SJ4202-8HG42	NSJ		
	3	5SJ4203-7HG42	NSJ		5SJ4203-8HG42	NSJ		
	4	5SJ4204-7HG42	NSJ		5SJ4204-8HG42	NSJ		
	5	5SJ4211-7HG42	NSJ		5SJ4211-8HG42	NSJ		
	6	5SJ4206-7HG42	NSJ		5SJ4206-8HG42	NSJ		
	8	5SJ4208-7HG42	NSJ		5SJ4208-8HG42	NSJ		
	10	5SJ4210-7HG42	NSJ		5SJ4210-8HG42	NSJ		
	13	5SJ4213-7HG42	NSJ		5SJ4213-8HG42	NSJ		
	15	5SJ4218-7HG42	NSJ		5SJ4218-8HG42	NSJ		
	16	5SJ4216-7HG42	NSJ		5SJ4216-8HG42	NSJ		
	20	5SJ4220-7HG42	NSJ		5SJ4220-8HG42	NSJ		
	25	5SJ4225-7HG42	NSJ		5SJ4225-8HG42	NSJ		
	30	5SJ4230-7HG42	NSJ		5SJ4230-8HG42	NSJ		
32	5SJ4232-7HG42	NSJ		5SJ4232-8HG42	NSJ			
35	5SJ4235-7HG42	NSJ		—	—			
40	5SJ4240-7HG42	NSJ		—	—			
 <p>3-pole</p> <p>*1 *3 *5 1 2 4 6</p>	0.3	5SJ4314-7HG42	NSJ		5SJ4314-8HG42	NSJ	0.465	
	0.5	5SJ4305-7HG42	NSJ		5SJ4305-8HG42	NSJ		
	1	5SJ4301-7HG42	NSJ		5SJ4301-8HG42	NSJ		
	1.6	5SJ4315-7HG42	NSJ		5SJ4315-8HG42	NSJ		
	2	5SJ4302-7HG42	NSJ		5SJ4302-8HG42	NSJ		
	3	5SJ4303-7HG42	NSJ		5SJ4303-8HG42	NSJ		
	4	5SJ4304-7HG42	NSJ		5SJ4304-8HG42	NSJ		
	5	5SJ4311-7HG42	NSJ		5SJ4311-8HG42	NSJ		
	6	5SJ4306-7HG42	NSJ		5SJ4306-8HG42	NSJ		
	8	5SJ4308-7HG42	NSJ		5SJ4308-8HG42	NSJ		
	10	5SJ4310-7HG42	NSJ		5SJ4310-8HG42	NSJ		
	13	5SJ4313-7HG42	NSJ		5SJ4313-8HG42	NSJ		
	15	5SJ4318-7HG42	NSJ		5SJ4318-8HG42	NSJ		
	16	5SJ4316-7HG42	NSJ		5SJ4316-8HG42	NSJ		
	20	5SJ4320-7HG42	NSJ		5SJ4320-8HG42	NSJ		
	25	5SJ4325-7HG42	NSJ		5SJ4325-8HG42	NSJ		
	30	5SJ4330-7HG42	NSJ		5SJ4330-8HG42	NSJ		
32	5SJ4332-7HG42	NSJ		5SJ4332-8HG42	NSJ			
35	5SJ4335-7HG42	NSJ		—	—			
40	5SJ4340-7HG42	NSJ		—	—			

1) Interrupting Rating to UL489, AC Max. RMS Symmetrical: Type NSJ = 10kA.

Control Circuit Protection













5SJ Branch Circuit Protection

Additional components for 5SJ4 Branch Circuit Protection

Features

- For use with the **5SJ4...-HG4** family of miniature circuit breakers
- UL Listed and CSA Certified to UL 489

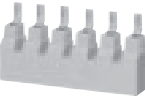
Selection and ordering data

		Order No.	List Price \$	Weight 1 item	
		1 item		kg	
	Auxiliary switches (AS)				
	 1 NO + 1 NC	5ST 3010-0HG		0.050	
	 2 NO	5ST 3011-0HG			
	 2 NC	5ST 3012-0HG			
	Fault signal contacts (FC)				
	 1 NO + 1 NC	5ST 3020-0HG		0.050	
	 2 NO	5ST 3021-0HG			
	 2 NC	5ST 3022-0HG			
	Shunt trip (ST)				
	 110 - 480 VAC	5ST 3030-0HG		0.098	
	 24 - 60 V AC/DC	5ST 3031-0HG		0.098	
	Busbars				
	Fixed lengths, cannot be cut¹⁾	Length			
	1-Pole	For 6 MCBs For 12 MCBs For 18 MCBs	100 mm 205 mm 310 mm	5ST 3663-0HG 5ST 3663-1HG 5ST 3663-2HG	0.056 0.112 0.170
	2-Pole	For 3 MCBs For 6 MCBs For 9 MCBs	100 mm 205 mm 310 mm	5ST 3664-0HG 5ST 3664-1HG 5ST 3664-2HG	0.065 0.137 0.211
	3-Pole	For 2 MCBs For 4 MCBs For 6 MCBs	100 mm 205 mm 310 mm	5ST 3665-0HG 5ST 3665-1HG 5ST 3665-2HG	0.067 0.155 0.243
	Connection terminals				
	Infeed - MCBs	35 mm ²	5ST 3666-0HG	0.033	
	Infeed - busbars	50 mm ²	5ST 3666-2HG	0.034	
	Touch protection covers¹⁾	3 x 1 pin	5ST 3666-1HG	0.003	

1) Always cover all exposed terminals with touch protection covers 5ST3666-1HG.

Control Circuit Protection

General Data

5SJ4 Branch Circuit Protection

Technical data

		5SJ41...HG40	5SJ4...HG41	5SJ4...HG42
Standards Certifications		EN 60898; EN 60947-2; UL 489; CSA C22.2 No. 5-02 CE; cULus, UL File No. E243414		
Tripping characteristic		B, C, D	C, D	
Number of poles		1	1, 2 & 3	
Operating voltage - IEC 60898 - UL 489 and CSA C22.2 No. 5-02	Min. V AC/DC	24		
	Max. V DC/pole	60		
	Max. V AC	440		
	Max. V AC	240 Same Polarity	240	480Y/277
V DC/1P	60	60	60	
V DC/2P, 3P	-	125	125	
Interrupting rating ¹⁾				
- I _{cn} to IEC 60898-1	kA AC	10		
- UL 489 and CSA C22.2 No. 5-02		Type NSJ: 10kA		
AC: Max. RMS Symmetrical	kA AC	Type HSJ: 14kA	Type NSJ: 10kA	
Touch protection to EN 50274		Yes		
Degree of protection to EN 60529		IP20, with connected conductors		
CFC and silicone free		Yes		
Mounting		On standard mounting rail (DIN 35 mm)		
Device depth		70 mm		
Terminals				
- Identical screw terminals on both line and load sides		Yes		
- Terminal tightening torque	lb. in.	31		
	Nm	3.5		
Conductor cross sections				
	mm ²	Solid and Stranded: 0.75 to 35		
	mm ²	Finely Stranded, with end sleeve: 0.75 to 25		
	AWG	14 to 4, 60/75°C, Cu Only		
Calibration Base		40 (UL 489) 30 (EN 60898)		
Average service life, with rated load		20,000 actuations		
Ambient temperature		-25 to 45, occasionally +55, max. 95% humidity		
Storage Temperature		-40 to +75		
Resistance to vibration to IEC 60068-2-6		60 at 10 Hz to 150 Hz		

1) See Selection and ordering data for specific device interrupting rating

Busbar & Connecting Terminals

Material Version		Busbars	Connecting Terminals	
		5ST3663	5ST3666-0HG	5ST3666-2HG
		5ST3664		
		5ST3665		
Standards Certifications		UL 489 UL Listed, File No. E243414		
Operating voltage				
- IEC 60898	VAC	690		
- UL 489	VAC	480Y/277 and 240		
Rated current to 40°C		115 A		
Busbar cross section		16 (Copper)		
Conductor cross sections				
	Solid and Stranded mm ²	-	2.5 to 35	2.5 to 50
	AWG	-	14 to 2	14 to 1
Terminal tightening torque				
	lb. in.	-	30	30
	Nm	-	3.3	3.3
Temperature Resistance		200 - UL 94-V0/0.4mm		

Technical data

Auxiliary Switch (AS), Fault Signal Contacts (FC) and Shunt Trip (ST)

Material Version	AS	FC	ST	
	5ST301-0HG	5ST302-0HG	5ST3030-0HG	5ST3032-0HG
Standards	UL 489; CSA C22.2 No. 5-02 IEC/EN 62019, IEC/EN 60947-5-1		IEC/EN 60947-1	
Certifications	CE, UL 489, CSA, UL File No. E321559			
Rated voltages/-load	IEC AC V 400 230		110 to 415	24 to 60
	AC A 2 6 (NC:AC13, NO: AC14)		-	-
	DC V 220 110 60 24		110	24 to 60
	DC A 1 1 3 6 (DC 13)		-	-
	UL AC V 480 277 240 120		110 to 480	24 to 60
	AC A 1.5 3 4 6		-	-
Contact load	min. 50 mA, 24 V		-	-
	Conductor cross-sections	AWG	22 ... 14	
		mm ²	0.5 ... 2.5	
Terminals - terminal tightening torque	Nm	0.5 max.		0.8 max.
	lb/in.	4.5		6.8

Applications

Auxiliary Switch (AS), Fault Signal Contact (FC) and Shunt Trip (ST) accessories are used with 5SJ4...-HG4. miniature circuit breakers (CB) and are mounted to the right of them.

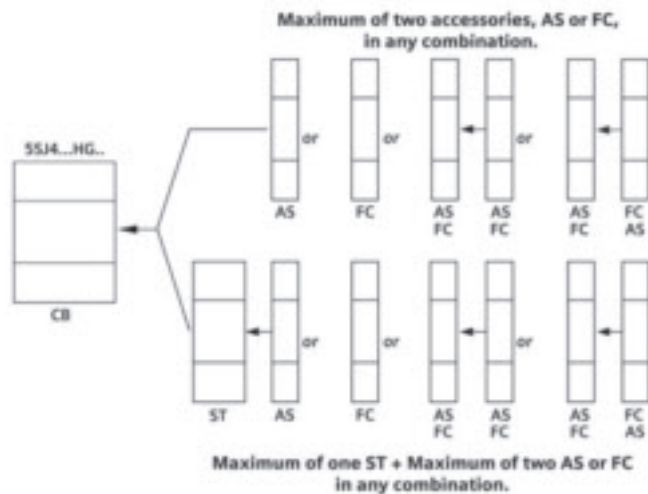

Dimensions

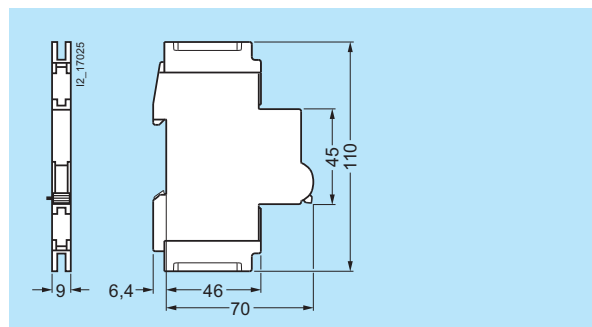

5ST3 010-0HG 5ST3 011-0HG 5ST3 012-0HG
5ST3 020-0HG 5ST3 021-0HG 5ST3 022-0HG

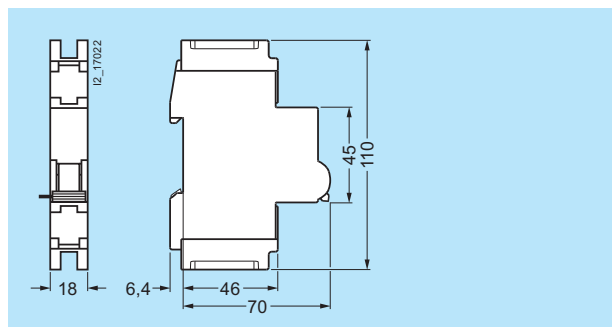

5ST3 030-0HG 5ST3 031-0HG

Control Circuit Protection

General Data

Dimensions

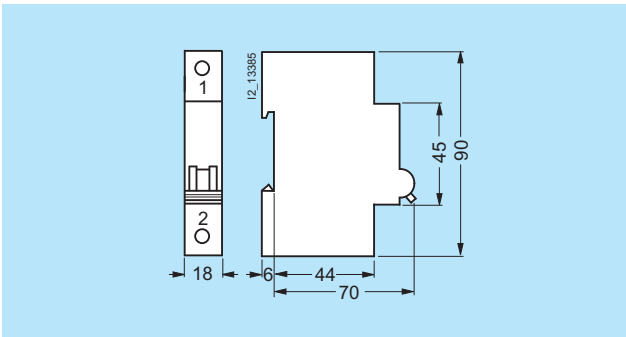

5SJ4...-HG40

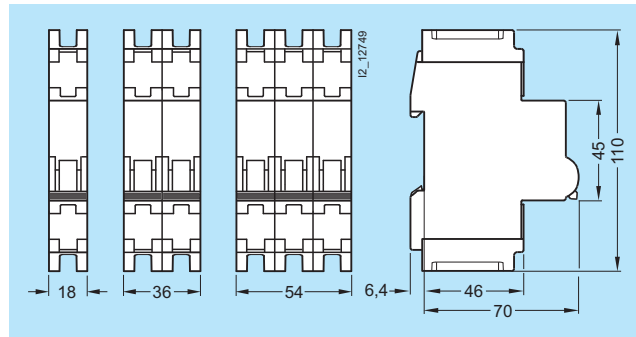

5SJ4...-HG41

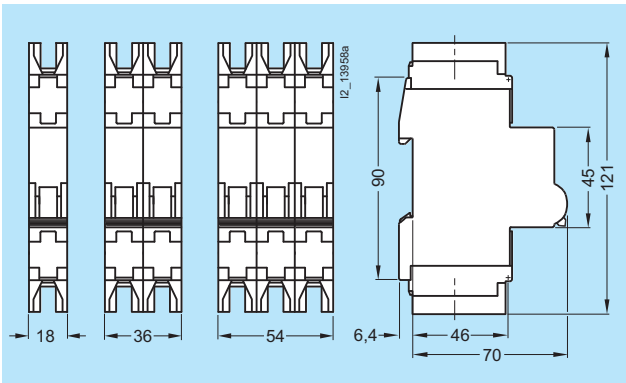

5SJ4...-HG42

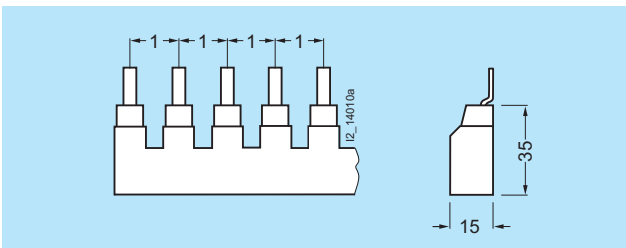

5ST3 663-0HG
5ST3 663-1HG
5ST3 663-2HG

5ST3 664-0HG
5ST3 664-1HG
5ST3 664-2HG

5ST3 665-0HG
5ST3 665-1HG
5ST3 665-2HG

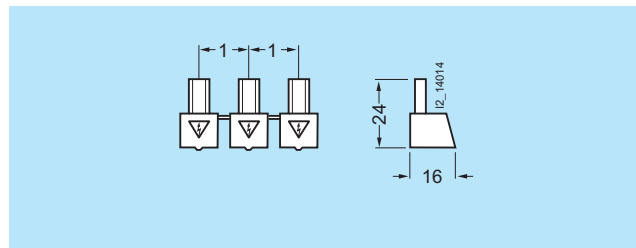

5ST3 666-1HG

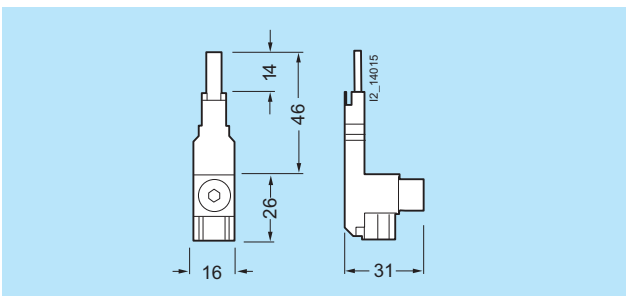

5ST3 666-0HG

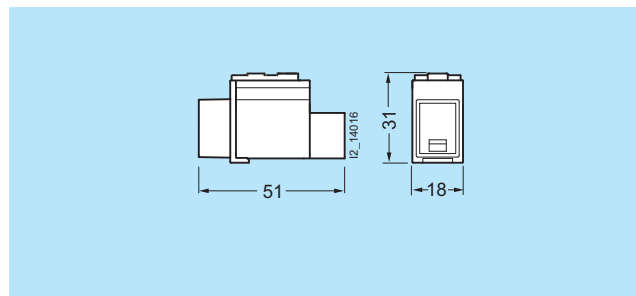

5ST3 666-2HG